

Section 18

Contactors and Starters-IEC



TeSys island Load Management System



TeSys D Contactors



TeSys F Contactors



TeSys GV3P



TeSys GV2P



TeSys U



TeSys H



Scan here to access our online digital easy motor control selectors

TeSys Selection Overview	18-2
Solutions that enhance machine intelligence	18-2
Traditional Control Solutions	18-2
Two-Component Motor Circuit Solutions to 520 amps	18-4
Digital Motor Control Solution	18-5
TeSys island Load Management System	18-5
Contactors and Overload Relays	18-8
TeSys™ K Contactors and Overload Relays	18-8
TeSys™ K Non-Reversing Mini-Contactors	18-8
TeSys™ K Overload Relays	18-9
TeSys™ K Reversing Mini-Contactors	18-9
TeSys™ D Contactors and Overload Relays	18-11
TeSys™ D Non-Reversing Contactors	18-11
TeSys™ D Overload Relays	18-12
TeSys™ D Reversing Contactors	18-13
TeSys™ F Contactors and Overload Relays	18-13
TeSys™ F Non-Reversing Contactors	18-14
TeSys™ F Overload Relays	18-14
TeSys™ F Reversing Contactors	18-15
Contactor Accessories	18-16
TeSys™ K Contactors	18-16
TeSys™ D and F Contactors	18-17
TeSys™ D Contactors	18-19
TeSys™ F Contactors	18-22
Overload Relay Accessories	18-23
TeSys™ D and F Overload Relays	18-23
Motor Starters and Protectors	18-25
TeSys™ U Open Motor Starter	18-25
TeSys™ H Ultra Compact Starters	18-29
TeSys™ GV Manual Starters and Protectors	18-30
TeSys™ GV Accessories and Enclosures	18-32
TeSys™ D Enclosed Starters	18-36
TeSys™ LS1 Fuse Holders	18-38
Soft Starter Module ATSU01	18-39
ATSU01 Altistart™ and TeSys™ U	18-39
Replacement Parts	18-40
TeSys™ D AC Coils	18-40
TeSys™ F Contactors	18-41
Wiring Systems	18-41
TeSys™ AK5 Panel Busbar System	18-41
Dimensions	18-42

TeSys Control Solutions

TeSys offers solutions for a variety of common control applications, including small to large loads, motor and non-motor loads, in various forms to meet customers specific needs. Basic solutions offer traditional approaches that meet compact, cost-effective, and large HP applications. TeSys also equips OEMs and System Integrators with EcoStruxure Machine connected product solutions that are IoT ready offers to help enhance the intelligence of machinery and equipment, helping to recognize and address potential issues before stoppage and decrease unplanned downtime.

Traditional Control

Table 18.1: Solutions that enhance machine intelligence













	Solution 1 — TeSys island as group motor	Solution 2 — TeSys island with individual protection	Solution 3 — TeSys U (Type E self-protected) using Multi-function trip unit & communication module or using pre-trip alarm function module	Solution 4 — TeSys T overload relay	Solution 5 — TeSys GV4PB, GV5PB, GV6PB with SDx Module
					
Best Practice Scenario	Ideal for panels with multiple loads . Single bus coupler serves as connection to PLC, manages logic and configuration for starters.	Ideal for panels with multiple loads . Single bus coupler serves as connection to PLC, manages logic and configuration for starters.	Ideal for panels with one or two motors . Each starter communicates directly to PLC.	Ideal for larger HP . Each overload relay communicates directly to PLC.	Ideal for adding intelligence using a simple NO/NC pre-trip alarm contact — Use of PLC to receive/interpret data not required.
Benefits	See load, device and system performance. Set alarms to anticipate maintenance and optimize performance.	See load, device and system performance. Set alarms to anticipate maintenance and optimize performance.	See load performance. Set alarms to anticipate maintenance and optimize performance.	See load performance. Set alarms to anticipate maintenance and optimize performance.	Pre-trip alarm NO/NC contact alerts prior to trip, enabling proactive actions to minimize downtime or alert operators
Circuit Protection	Circuit breaker or fuse protection group	Circuit breaker or fuse	TeSys U (applied as Type E self protected), using advanced trip unit/function modules	Breaker or fuse	GV4PB, GV5PB, GV6PB
Motor Control	TeSys island load management system with or without TeSys GV	TeSys island load management system		TeSys D or F contactors	TeSys D or F
Motor Overload Protection				TeSys T overload relay	(included in GV*PB)
Load Types	Motor, resistive/non-inductive, isolation	Motor, resistive/non-inductive, isolation	Motor loads only	Motor loads only	Motor loads only
Max HP 480V	40 HP	40 HP	20 HP	500 HP (up to 810 amps)	450 HP (up to 520 amps)
SCCR	basic 5 kA up to high 50 kA (with GV)	high, to 100 kA	High, to 65 kA	Depends on configuration	Depends on configuration
Available data	Device status/performance Load performance including alarms Voltage, Energy & Power	Device status/performance Load performance including alarms Voltage, Energy & Power	Load performance including alarms	Load performance including alarms Voltage & Power	Pre-trip alarm (via NO/NC contact)
Communication	Ethernet IP, Modbus TCP, Profinet, Profibus	Ethernet IP, Modbus TCP, Profinet, Profibus	Modbus™, CANopen, DeviceNet™, Profibus™	Modbus™, CANopen, DeviceNet™, Profibus™, Ethernet/IP, and Modbus/TCP	None

Table 18.2: Basic — Traditional motor control solution

	Solution 1 — Two component solution (TeSys GV + D)		Solution 2 — Single component solution	Solution 3 — Group Motor solution	Solution 5 — Three component solution (Breaker/ fuse, contactor & overload relay)	Solution 6 — Type D solution (Motor circuit protector, contactor & overload relay)	Solution 7 — Non-motor load solution (Breaker/fuse + contactor)	
	Type F — up to 65 amps	Motor Protective Circuit Breakers + contactor - up to 520 amps	Type E — up to 32 amps	up to 65 amps				
								
Best Practice Scenario	Most cost effective, high SCCR solution		Most compact, also ideal for critical uptime applications (resetable after a short-circuit with no component replacement), high SCCR solution	Few components, 480V delta rated	3-component solution, ideal for higher HPs or high SCCR	ideal for pumping applications, includes adjustable motor inrush sensitivity	ideal for non-motor loads	
Benefits	Simple, 2-component solution, cost effective, fast power wiring using bus bars	Simple, 2-component solution, cost effective for larger HP motors	Single component solution, Type 2 rated (minimize downtime after short-circuit)	cost effective solution ideal for panels with many motor loads (single breaker for multiple starters)	basic solution, ideal for 480V delta applications, resetable after breaker trip	adjustable motor inrush sensitivity, ideal for pumping applications	ideal for non-motor loads	
Circuit Protection	TeSys GV2P, GV3P (applied as Type F with contactor)	TeSys GV4PB, GV5PB, GV6PB (UL 489)	TeSys U, with basic trip unit	PowerPact or Multi9 (UL 489) or fuses	PowerPact or Multi9 (UL 489) or TeSys DF, LS1 fuseholder, GS disconnect with fuses	TeSys BV4 (UL 489)	PowerPact or Multi9 (UL 489) or TeSys DF, LS1 fuseholder, GS disconnect with fuses	
Motor Control	Tesys D	TeSys D or F		TeSys D	TeSys D or F	TeSys D	TeSys D or F	
Motor Overload Protection	(included in GV)	(included in GV)		TeSys GV2ME	LR thermal or LR9 electronic	LR thermal or LR9 electronic	—	
Load Types	Motor loads only	Motor loads only	Motor loads only	Motor loads only	Motor loads only	Motor loads only	Resistive/non-inductive, isolation	

Refer to Catalog MKTED210011EN

Two-Component Motor Circuit Solutions to 520 Amps

Simplify design, panel space and installation with TeSys high SCCR solution that use only two components that make up an entire branch circuit up to 520 amps. These two-component solutions are UL compliant using either a Type F combination motor controller rating or a UL 489 rating. For additional solutions and ratings, see Motor Control Solutions for North America data bulletin 8536DB0901.



Table 18.3: Quick selection table for TeSys 2–component motor circuit solutions

200 V 3P		230 V 3P		460 V 3P		GV Ref	Overload Dial Range (A)	Contactor Ref/Contactor Ref ^[1]	Pre-assembled Ref/Contactor Ref ^[1]	SCCR 480Y as applied with specified protection
HP	FLA ^[2]	HP	FLA ^[2]	HP	FLA ^[2]					
—	—	—	—	1/2	1.1	GV2P06	1 to 1.6	LC1D09	GV2P06KD09	100 kA ^[3]
—	—	—	—	3/4	1.6	GV2P06	1 to 1.6	LC1D09	GV2P06KD09	100 kA ^[3]
1/2	2.5	1/2	2.2	1	2.1	GV2P07	1.6 to 2.5	LC1D09	GV2P07KD09	100 kA ^[3]
—	—	—	—	1 1/2	3	GV2P08	2.5 to 4	LC1D09	GV2P08KD09	100 kA ^[3]
3/4	3.7	3/4	3.2	2	3.4	GV2P08	2.5 to 4	LC1D09	GV2P08KD09	100 kA ^[3]
1	4.6	1	4.2	3	4.8	GV2P10	4 to 6.3	LC1D09	GV2P10KD09	100 kA ^[3]
—	—	1 1/2	6	—	—	GV2P10	4 to 6.3	LC1D09	GV2P10KD09	100 kA ^[3]
1 1/2	6.9	2	6.8	—	—	GV2P14	6 to 10	LC1D12	GV2P14KD09	100 kA ^[3]
2	7.8	—	—	5	7.6	GV2P14	6 to 10	LC1D12	GV2P14KD09	100 kA ^[3]
—	—	3	9.6	—	—	GV2P16	9 to 14	LC1D12	GV2P16KD25	50 kA ^[4]
3	11	—	—	7 1/2	11	GV2P16	9 to 14	LC1D18	GV2P16KD25	50 kA ^[4]
—	—	—	—	10	14	GV2P16	9 to 14	LC1D18	GV2P16KD25	50 kA ^[4]
5	17.5	5	15.2	—	—	GV2P20	13 to 18	LC1D18	GV2P20KD25	50 kA ^[4]
—	—	7 1/2	22	15	21	GV2P21	17 to 23	LC1D25	GV2P21KD25	50 kA ^[4]
7 1/2	25.3	—	—	—	—	GV2P22	20 to 25	LC1D25	GV2P22KD25	50 kA ^[4]
—	—	10	28	20	27	GV3P32	23 to 32	LC1D32	—	65 kA ^[5]
10	32.2	—	—	25	34	GV3P40	30 to 40	LC1D40A	—	65 kA ^[5]
—	—	15	42	30	40	GV3P50	37 to 50	LC1D50A	—	65 kA ^[5]
15	48	20	54	40	52	GV3P65	48 to 65	LC1D65A	—	65 kA ^[5]
20	62.1	25	68	50	65	GV4PB115S	65 to 115	LC1D80	—	65 kA
25	78.2	30	80	60	77	GV4PB115S	65 to 115	LC1D80	—	65 kA
30	92	—	—	—	—	GV4PB115S	65 to 115	LC1D115	—	65 kA
—	—	40	104	75	96	GV5PB150S	58 to 130	LC1D115	—	65 kA
40	120	—	—	—	—	GV5PB150S	58 to 130	LC1D150	—	65 kA
—	—	50	130	100	124	GV5PB250S	114 to 217	LC1D150	—	65 kA
50	150	60	154	125	156	GV5PB250S	114 to 217	LC1D185	—	65 kA ^[6]
60	177	75	192	150	180	GV5PB250S	114 to 217	LC1F265	—	10 kA ^[7]
75	221	100	248	200	240	GV6PB400S	190 to 348	LC1F330	—	10 kA ^[7]
100	285	125	312	250	302	GV6PB400S	190 to 348	LC1F400	—	18 kA
125	359	150	360	300	361	GV6PB600S	312 to 520	LC1F500	—	18 kA
150	414	200	480	400	477	GV6PB600S	312 to 520	LC1F500	—	18 kA
200	552	—	—	450	515	GV6PB600S	312 to 520	LC1F630	—	30 kA

18 CONTACTORS AND STARTERS-IEC

[1] Add coil suffix to complete reference part number (See Table 18.24 TeSys D Coil Voltage Codes , page 18-11 for LC1D and Table 18.30 TeSys F Coil Voltage Codes, page 18-14 for LC1F). For example, an LC1D09G7 includes a 120 Vac coil.
 [2] Motor Full Load Amp Sizes are based on NEC Table 430.250.
 [3] Requires use of GV1G09 or GV2GH7 line spacer for Type F rating. SCCR is 100 kA at 480Y with or without use of GV2G busbar links.
 [4] Requires use of GV1G09 or GV2GH7 line spacer for Type F rating. SCCR is 42 kA at 480Y when using GV2G busbar links.
 [5] Requires use of GV3G66 line spacer and GVAM11 short-circuit signaling contact for Type F rating.
 [6] Max wire size of 3/0 AWG for 65kA 480 V SCCR.
 [7] 100kA SCCR with fuses. See Motor Control Solutions for North America data bulletin 8536DB0901 for more information.

Island Concept

TeSys island is an innovative digital load management solution—providing data for higher machine efficiency and ease of servicing, and allowing faster time to market.

TeSys island is a modular, multifunctional system providing integrated functions inside an automation architecture, primarily for the direct control and management of low-voltage loads. TeSys island can switch, help protect, and manage motors and other electrical loads up to 40 hp, 80 A installed in an electrical control Panel.

This system is designed around the concept of TeSys™ avatars.

These avatars:

- are the functional object representing a logical function of the physical module with pre-defined logic
- determine the configuration of the island.

The logical aspects of the island are managed with software tools, covering all phases of product and application lifecycle: design, engineering, commissioning, operation, and maintenance.



1	Bus Coupler	5	Power interface module
2	Analog I/O module	6	Standard Starter
3	Digital I/O module	7	SIL Starter
4	Voltage interface module	9	SIL interface module

The physical island consists of a set of devices installed on a single DIN rail controlling loads, monitoring data, diagnostics information and connected together with a ribbon cable providing the internal communication between modules.

The external communication with the automation environment is made via a single coupler module, and the island is seen as a single node on the network. The other modules include starters, power interface modules, analog and digital I/O modules, voltage interface modules, and SIL interface modules, covering a wide range of operational functions.

Product References

The TeSys island load management system consists of a bus coupler along with other starters and modules as needed to build an “island” of load management, monitoring & control functions. It is recommended to use the online EcoStruxure Motor Control Configurator to ensure proper application and sizing.



Scan here to access our online EcoStruxure Motor Control Configurator

Table 18.4: Bus Couplers

Designation	Upstream PLC protocol	Service Port protocol	Product Reference	Weight (kg)
TeSys island Bus Coupler	EtherNet/IP-Modbus TCP	Ethernet TCP/IP	TPRBCEIP	0.204
	PROFINET	Ethernet TCP/IP	TPRBCPFN	0.204
	PROFIBUS	Ethernet TCP/IP	TPRBCPFB	0.204

Table 18.5: 3-Pole Starters

Maximum Horsepower Ratings							Continu-ous Current Rating (A)	Product Reference	Weight (kg)
Single-Phase		Three-Phase							
115 V	230 V	200 V	230 V	460 V	575 V				
1/3	1	2	2	5	5	15	TPRST009	0.656	
2	3	7 1/2	7 1/2	15	20	30	TPRST025	0.718	
2	5	10	10	20	25	40	TPRST038	0.718	
5	10	20	20	40	50	80	TPRST065	1.248	
5	10	20	20	40	50	80	TPRST080	1.248	



TPRBCEIP



TPRST009



TPRS025



TPRSM001



TPRVM001



TPRDG4X2

Table 18.6: 3-Pole SIL Starters

Maximum Horsepower Ratings							Continu-ous Current Rating (A)	Product Reference	Weight (kg)
Single-Phase		Three-Phase							
115 V	230 V	200 V	230 V	460 V	575 V				
1/3	1	2	2	5	5	15	TPRSS009	0.656	
2	3	7 1/2	7 1/2	15	20	30	TPRSS025	0.718	
2	5	10	10	20	25	40	TPRSS038	0.718	
5	10	20	20	40	50	80	TPRSS065	1.248	
5	10	20	20	40	50	80	TPRSS080	1.248	

Table 18.7: 3-Pole PIM Starters

Maximum Horsepower Ratings						Continu-ous Current Rating (A)	Product Reference	Weight (kg)
Single-Phase		Three-Phase						
115 V	230 V	200 V	230 V	460 V	575 V			
1/3	1	2	2	5	5	15	TPRP-M009	0.255
2	5	10	10	20	25	40	TPRP-M038	0.255
5	10	20	20	40	50	80	TPRP-M080	0.425

Table 18.8: SIL Interface Module

Designation	Voltage (Vdc)	Product Reference	Weight (kg)
TeSys island SIL interface module (SIM)	24	TPRSM001	0.159

Table 18.9: Voltage Interface Module (VIM)

Designation	Phase	Voltage (V)	Frequency (Hz)	Product Reference	Weight (kg)
TeSys island Voltage interface module (SIM)	1P/3P	100 to 690	50–60	TPRVM001	0.159

Table 18.10: Digital I/O Module

Designation	Input Vdc	Output A / Vdc	Frequency (Hz)	Product Reference	Weight (kg)
TeSys island DG—Digital 4I/2O Module	24	0.5 / 24	50–60	TPRDG4X2	0.136

Table 18.11: Analog I/O Module

Designation	Inputs		Output		Product Reference	Weight (kg)
	mA dc	Vdc	mA dc	Vdc		
	TeSys island—Analog 2I/2O Module	0–20	–10 to +10	0–20		
	40–20	0–10	4–20	0–10		

TeSys™ K Non-Reversing Mini-Contactors



LC1K09



LP4K09

Table 18.12: Mini-Contactors with AC Operating Coils

Maximum Horsepower Ratings						Maximum Current (A)		Continuous Current Rating (A)	Type of Connection	Auxiliary Contacts		Catalog Number [1][2]
Single-Phase		Three-Phase				Inductive AC3	Resistive AC1			N.O.	N.C.	
115 V	230 V	200 V	230 V	460 V	575 V							
0.5	1	1.5	1.5	3	3	6	20	10	Screw-clamp	1	—	LC1K0610
—	—	—	—	—	—	—	—	—	—	1	—	LC1K0601
0.5	1.5	2	3	5	5	9	20	20	Screw-clamp	1	—	LC1K0910
—	—	—	—	—	—	—	—	—	—	—	1	LC1K0901
1	2	3	3	7.5	10	12	20	20	Screw-clamp	1	—	LC1K1210
—	—	—	—	—	—	—	—	—	—	—	1	LC1K1201
4-Pole Mini Contactor												
1/2	1.5	2	3	5	5	9	20	20	Screw-clamp	4	—	LC1K09004
—	—	—	—	—	—	—	—	—	—	2	2	LC1K09008
1	2	3	3	7.5	10	12	20	20	Screw-clamp	4	—	LC1K12004
4-Pole Mechanically Interlocked Contactors												
1/2	1.5	2	3	5	5	9	20	20	Screw-clamp	4	—	LC2K09004
1	2	3	3	7.5	10	12	20	20	Screw-clamp	4	—	LC2K12004

Table 18.13: Coil Voltage Codes for AC Contactors

Vac 50/60 Hz	24	110	120	230/240
Code	B7	F7	G7	U7

Table 18.14: Mini-Contactors with 24 Vdc Operating Coils

Maximum Horsepower Ratings						Maximum Current (A)		Continuous Current Rating (A)	Type of Connection	Auxiliary Contacts		Catalog Number [2]
Single-Phase		Three-Phase				Inductive AC3	Resistive AC1			N.O.	N.C.	
115 V	230 V	200 V	230 V	460 V	575 V							
0.5	1	1.5	1.5	3	3	6	20	10	Screw-clamp	1	—	LP1K0610BD
—	—	—	—	—	—	—	—	—	—	—	1	LP1K0601BD
0.5	1.5	2	3	5	5	9	20	20	Screw-clamp	1	—	LP1K0910BD
—	—	—	—	—	—	—	—	—	—	—	1	LP1K0901BD
1	2	3	3	7.5	10	12	20	20	Screw-clamp	1	—	LP1K1210BD
—	—	—	—	—	—	—	—	—	—	—	1	LP1K1201BD
4-Pole Mini Contactor												
1/2	1.5	2	3	5	5	9	20	20	Screw-clamp	4	—	LP1K09004BD
—	—	—	—	—	—	—	—	—	—	2	2	LP1K09008BD
1	2	3	3	7.5	10	12	20	20	Screw-clamp	4	—	LP1K12004BD
4-Pole Mechanically Interlocked Contactors												
1/2	1.5	2	3	5	5	9	20	20	Screw-clamp	4	—	LP2K09004BD
1	2	3	3	7.5	10	12	20	20	Screw-clamp	4	—	LP2K129004BD

Table 18.15: Mini-Contactors with Low-Consumption 24 Vdc Operating Coil (includes built-in transient suppression) [3]

Maximum Horsepower Ratings						Maximum Current (A)		Continuous Current Rating (A)	Type of Connection	Auxiliary Contacts		Catalog Number [2]
Single-Phase		Three-Phase				Inductive AC3	Resistive AC1			N.O.	N.C.	
115 V	230 V	200 V	230 V	460 V	575 V							
0.5	1	1.5	1.5	3	3	6	20	10	Screw-clamp	1	—	LP4K0610BW3
—	—	—	—	—	—	—	—	—	—	—	1	LP4K0601BW3
0.5	1.5	2	3	5	5	9	20	20	Screw-clamp	1	—	LP4K0910BW3
—	—	—	—	—	—	—	—	—	—	—	1	LP4K0901BW3
1	2	3	3	7.5	10	12	20	20	Screw-clamp	1	—	LP4K1210BW3
—	—	—	—	—	—	—	—	—	—	—	1	LP4K1201BW3

[1] Complete the catalog number with the coil voltage from (for example LC1K0610G7).

[2] For additional terminal options and coil voltage/consumption options, see Catalog MKTED210011EN. Check with local sales office for availability.

[3] 1.8 W inrush.

TeSys™ K Overload Relays

Table 18.16: Overload Relays for 3-Pole Contactors with Screw-Clamp Terminals



LR2K0316

Current Setting Range (A)	Catalog Number
0.11 to 0.16	LR2K0301
0.16 to 0.23	LR2K0302
0.23 to 0.36	LR2K0303
0.36 to 0.54	LR2K0304
0.54 to 0.8	LR2K0305
0.8 to 1.2	LR2K0306
1.2 to 1.8	LR2K0307
1.8 to 2.6	LR2K0308
2.6 to 3.7	LR2K0310
3.7 to 5.5	LR2K0312
5.5 to 8	LR2K0314
8 to 11.5	LR2K0316
10 to 14	LR2K0321 [4]

LR2K overload relays:

- AC or DC protection
- Ambient compensated bimetallic
- Class 10
- Single phase sensitivity
- Manual or auto reset
- Full load current dial



E164862
CCN NLDX
(screw terminals)



E164862
CCN NLDX2
(slip-on and solder-pin terminals)



LR43364
Class 3211 04



Accessories: [page 18-16](#)
Dimensions: [page 18-56](#)

TeSys™ K Reversing Mini-Contactors

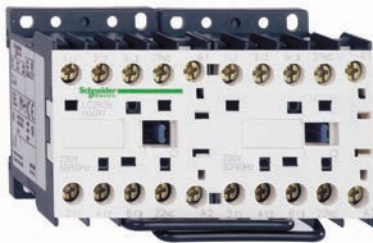

LC2K0910

Table 18.17: AC Operating Coils

Maximum Horsepower Ratings						Maximum Current (A)		Continuous Current Rating (A)	Type of Connection	Auxiliary Contacts		Catalog Number [5][6]
Single-Phase		Three-Phase				Inductive AC3	Resistive AC1			N.O.	N.C.	
115 V	230 V	200 V	230 V	460 V	575 V							
1/2	1	1.5	1.5	3	3	6	20	10	Screw-clamp	1	—	LC2K0610
										—	1	LC2K0601
1/2	1.5	2	3	5	5	9	20	20	Screw-clamp	1	—	LC2K0910
										—	1	LC2K0901
1	2	3	3	7.5	10	12	20	20	Screw-clamp	1	—	LC2K1210
										—	1	LC2K1201

Table 18.18: Coil Voltage Codes for AC Contactors

Vac 50/60 Hz	24	110	120	230/ 240
Code	B7	F7	G7	U7

[4] Not UL Listed.

[5] Complete the catalog number with the coil voltage code from [Table 18.18](#) (for example, [LC2K0610G7](#)).

[6] For additional terminal options and coil options, see Catalog [MKTED210011EN](#). Check with local sales office for availability.

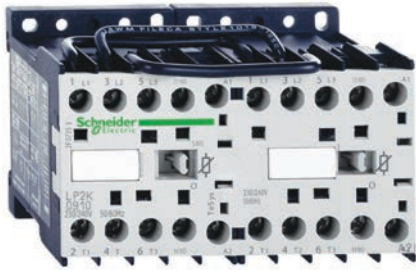

LP2K0910

Table 18.19: DC Operating Coils

Maximum Horsepower Ratings						Maximum Current (A)		Continuous Current Rating (A)	Type of Connection	Auxiliary Contacts		Catalog Number [7]
Single-Phase		Three-Phase				Inductive AC3	Resistive AC1			N.O.	N.C.	
115 V	230 V	200 V	230 V	460 V	575 V							
1/2	1	1.5	1.5	3	3	6	20	10	Screw-clamp	1	—	LP2K0610BD
										—	1	LP2K0601BD
1/2	1.5	2	3	5	5	9	20	20	Screw-clamp	1	—	LP2K0910BD
										—	1	LP2K0901BD
1	2	3	3	7.5	10	12	20	20	Screw-clamp	1	—	LP2K1210BD
										—	1	LP2K1201BD



LC2K090045

Table 18.20: Coil Voltage Codes for DC Contactors

Coil with integral suppression device available. Add 3 to the code required. Example: JD3 [8]

Vdc	12	20	24	36	48	60	72	100	110	125	200	220	230	240	250
Code	JD	ZD	BD	CD	ED	ND	SD	KD	FD	GD	LD	MD	MPD	MUD	UD

Table 18.21: Coil Voltages for DC Contactors—Low Consumption [9]

Vdc	12	24	48	72
Code	JW3	BW3	EW3	SW3

Overload Relays: [page 18-9](#)
Accessories: [page 18-16](#)
Dimensions: [page 18-56](#)

[7] For additional terminal options and coil options, see Catalog [MKTED210011EN](#). Check with local sales office for availability.

[8] 3 W inrush.

[9] 1.8 W inrush.

TeSys™ D Non-Reversing Contactors



LC1D09



LC1D40A

Table 18.22: TeSys D Contactors—3 or 4 Pole, Screw Terminal Connections

Maximum Horsepower Ratings						Maximum Current (A)		Continuous Current Rating (A)	No. of Poles		Instantaneous Auxiliary Contacts		Catalog Number [10][11]
Single-Phase		Three-Phase				Inductive AC3	Resistive AC1		N.O.	N.C.	N.O.	N.C.	
115 V	230 V	200 V	230 V	460 V	575 V								
1/3	1	2	2	5	7.5	9	20	25	3	0	1	1	LC1D09
—	—	—	—	—	—	—			4	0			LC1DT20
—	—	—	—	—	—	—	25	25	2	2	1	1	LC1D098
1/2	2	3	3	7.5	10	12			3	0			LC1D12
—	—	—	—	—	—	—	32	32	4	2	1	1	LC1DT25
—	—	—	—	—	—	—			2	2			LC1D128
1	3	5	5	10	15	18	40	40	3	0	1	1	LC1D18
—	—	—	—	—	—	—			4	0			LC1DT32
—	—	—	—	—	—	—	50	50	2	2	1	1	LC1D188
2	3	7.5	7.5	15	20	25			3	0			LC1D25
—	—	—	—	—	—	—	60	60	4	0	1	1	LC1DT40
—	—	—	—	—	—	—			2	2			LC1D258
2	5	10	10	20	25	32	80	80	3	0	1	1	LC1D32
2	5	10	10	20	25	38			3	0			LC1D38
3	5	10	10	30	30	40	125	110	3	0	1	1	LC1D40A
—	—	—	—	—	—	—			4	0			0
3	7.5	15	15	40	40	50	200	160	3	0	1	1	LC1D50A
5	10	20	20	40	50	65			3	0			1
—	—	—	—	—	—	—	250	200	4	0	0	0	LC1DT80A
—	—	—	—	—	—	—			3	0			1
7.5	15	25	30	60	60	80	300	250	3	0	1	1	LC1D80004
—	—	—	—	—	—	—			4	0			0
—	—	—	—	—	—	—	480	375	2	2	1	1	LC1D95
7.5	15	25	30	60	60	95			3	0			1
—	—	30	40	75	100	115	900	750	3	0	1	1	LC1D150
—	—	40	50	100	125	150			3	0			0

Table 18.23: Definite Purpose Ratings, 3-Phase, Breaking All Lines, 100,000 Cycles (Hermetic Refrigeration Compressor)

Device	FLA	LRA		
		240 V	480 V	600 V
LC1D09 (AC coil only)	9	54	45	36
LC1D12 (AC coil only)	12	72	60	48
LC1D18 (AC coil only)	18	108	90	72
LC1D25 (AC coil only)	25	150	125	100
LC1D32 (AC coil only)	32	192	160	128
LC1D40A	40	240	200	160
LC1D50A	50	300	250	200
LC1D65A	65	390	325	260
LC1D80	75	450	375	300
LC1D115	115	690	575	460
LC1D150	150	900	750	600

Table 18.24: TeSys D Coil Voltage Codes

Contactor	D09–D38	D40A–D65A	D80–D150
AC 50/60 Hz			
24 V	B7	B7	B7
110 V	F7	F7	F7
120 V	G7	G7 [12]	G7
240 V	U7	U7	U7
480 V	T7	T7	T7
AC/DC			
24–60 V	BNE	BNE	—
48–130 V	EHE	EHE	—
100–250 V	KUE	KUE	—
DC			
24 V	BL	BBE	BD

[10] Complete the catalog number by adding the coil voltage code from Table 18.24 for example, LC1D09G7.
 [11] For additional terminal options and coil options, see Catalog MKTED210011EN. Check with local sales office for availability.
 [12] 60 Hz only

TeSys™ D Overload Relays



LRD10



LR9D32

Table 18.25: TeSys D Overload Relays—Ambient Compensated, Bimetallic, Direct Mounting

Current Setting Range (A)	For Direct Mounting to LC1D/LC2D...	Class 10 with Single-Phase Sensitivity	Class 10 without Single-Phase Sensitivity	Class 20 with Single-Phase Sensitivity	Class 20 without Single-Phase Sensitivity
0.10–0.16	D09–D38	LRD01	LR3D01	—	—
0.16–0.25		LRD02	LR3D02	—	—
0.25–0.40		LRD03	LR3D03	—	—
0.40–0.63		LRD04	LR3D04	—	—
0.63–1		LRD05	LR3D05	LRD05L	—
1–1.6		LRD06	LR3D06	LRD06L	—
1.6–2.5		LRD07	LR3D07	LRD07L	LR3D07L
2.5–4		LRD08	LR3D08	LRD08L	LR3D08L
4–6		LRD10	LR3D10	LRD10L	LR3D10L
5.5–8		LRD12	LR3D12	LRD12L	LR3D12L
7–10	LRD14	LR3D14	LRD14L	LR3D14L	
9–13	D12–D38	LRD16	LR3D16	LRD16L	LR3D21L
12–18	D18–D38	LRD21	LR3D21	LRD21L	LR3D21L
16–24		LRD22	LR3D22	—	—
17–24		—	—	LRD22L	LR3D22L
23–32	D25–D38	LRD32	LR3D32	LRD32L	LR3D32L
30–38	D32–D38	LRD35	LR3D35	—	—
9–13	D40A–D65A	LRD313	LR3D313	LRD313L	—
12–18	D40A–D65A	LRD318	LR3D318	LRD318L	—
17–25	D40A–D65A	LRD325	LR3D325	LRD325L	—
23–32	D40A–D65A	LRD332	LR3D332	LRD332L	—
30–40	D40A–D65A	LRD340	LR3D340	LRD340L	—
37–50	D40A–D65A	LRD350	LR3D350	LRD350L	—
48–65	D40A–D65A	LRD365	LR3D365	LRD365L	—
17–25	D40–D95	LRD3322	LR3D3322	LR2D3522	LR3D3522
23–32	D40–D95 [13]	LRD3353	LR3D3353	LR2D3553	LR3D3553
30–40	D40–D95 [13]	LRD3355	LR3D3355	LR2D3555	LR3D3555
37–50	D50–D95 [13]	LRD3357	LR3D3357	LR2D3557	LR3D3557
48–65	D50–D95 [13]	LRD3359	LR3D3359	LR2D3559	LR3D3559
55–70	D65–D95	LRD3361	LR3D3361	LR2D3561	LR3D3561
63–80	D65–D95	LRD3363	LR3D3363	LR2D3563	LR3D3563
80–104	D95	LRD3365	—	—	—
80–104	D115–D150	LRD4365	—	—	—
95–120	D115–D150	LRD4367	—	—	—
110–140	D150	LRD4369	—	—	—

Table 18.26: TeSys LR9D Electronic Overload Relays ^{New!}

Current Setting Range (A)	For Direct Mounting Beneath Contactor LC1D/LC2D	Class 5/10/20/30 Selectable
0.1–0.5	D09–D38	LR9D01
0.4–2	D09–D38	LR9D02
1.6–8	D09–D38	LR9D08
6.4–32	D09–D38	LR9D32

Table 18.27: TeSys D Overload Relays—Solid State

Current Setting Range (A)	For Direct Mounting Beneath Contactor LC1	Class 10	Class 20	Class 10/20 Selectable
60–100	D115–D150	LR9D5367	LR9D5567	LR9D67
90–150	D115–D150	LR9D5369	LR9D5569	LR9D69

TeSys D contactor accessories: [page 18-17](#)
 TeSys D overload relay accessories: [page 18-23](#)
 TeSys D replacement coils: [page 18-40](#)
 Dimensions: [page 18-42](#) to [page 18-52](#)

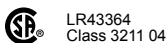
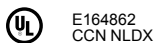

[13] Direct Mount to old D2 style D40 to D65 (no Everlink terminations) and to D80 and D95 only.

TeSys™ D Reversing Contactors

Each 3-pole device is prewired with line and load side power wiring for reversing applications. Each 4-pole device is prewired with load side power wiring.

Table 18.28: TeSys D Mechanically-Interlocked Reversing Contactors

	Maximum Horsepower Ratings						Maximum Current (A)		Continuous Current Rating (A)	No. of N.O. Power Poles	Built In Auxiliary Contacts (per contactor)		Catalog Number [14][15][16]
	Single-Phase		Three-Phase				Inductive AC3	Resistive AC1			N.O.	N.C.	
	115 V	230 V	200 V	230 V	460 V	575 V							
	1/3	1	2	2	5	7.5	9	20	25	3	1	1	LC2D09
	1/2	2	3	3	7.5	10	12	25	25	3	1	1	LC2D12
	1	3	5	5	10	15	18	32	32	3	1	1	LC2D18
	2	3	7.5	7.5	15	20	25	40	40	3	1	1	LC2D25
	2	5	10	10	20	25	32	50	50	3	1	1	LC2D32
	2	5	10	10	20	25	38			3	1	1	LC2D38
	3	5	10	10	30	30	40	60	60	3	1	1	LC2D40A
	3	7.5	15	15	40	40	50			3	1	1	LC2D50A
	5	10	20	20	40	50	65	80	80	3	1	1	LC2D65A
	7.5	15	25	30	60	60	80			3	1	1	LC2D80
	7.5	15	25	30	60	60	95	125	110	3	1	1	LC2D95
	—	—	30	40	75	100	115			3	1	1	LC2D115[17]
	—	—	40	50	100	125	150	200	160	3	1	1	LC2D150[17]
	—	—	—	—	—	—	—			3	1	1	—

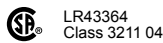
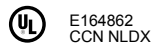

TeSys D contactor accessories: [page 18-17](#)
TeSys D replacement coils: [page 18-40](#)
TeSys D dimensions: [page 18-42](#) to [page 18-52](#)

[14] Includes mechanical interlock without electrical contacts. Installer to complete wiring for electronically interlocking contactor operating coils by using a N.C. auxiliary contact integrated in the contactor or optional LADN or LAD8N auxiliary contact block.
[15] Complete the catalog number by adding the coil voltage code from [Table 18.24 TeSys D Coil Voltage Codes](#), [page 18-11](#) (for example, LC2D09KUE).
[16] For additional terminal options and coil voltage/consumption options, see Catalog [MKTED210011EN](#). Check with local sales office for availability.
[17] Includes mechanical interlock (LA9D11502) with prewired electrical contacts for interlocking contactor operating coils.

TeSys™ F Non-Reversing Contactors

Table 18.29: TeSys F Contactors—3 Pole



	Maximum Three-Phase Horsepower Ratings				Maximum Current (A)		Continuous Current Rating (A)	Number of Poles	Catalog Number [18]		
	200 V	230 V	460 V	575 V	Inductive AC-3	Resistive AC-1			[19]		
 <p>LC1F330</p>	30	40	75	100	115	200	175	3	LC1F115		
	40	50	100	125	150	250	200	3	LC1F150		
	50	60	125	150	185	275	200	3	LC1F185		
	60	75	150	150	225	315	250	3	LC1F225		
	60	75	150	200	265	350	285	3	LC1F265		
	75	100	200	250	330	400	370	3	LC1F330		
	100	125	250	300	400	500	420	3	LC1F400		
	150	200	400	500	500	700	700	3	LC1F500		
	250	300	600	800	630	1000	1000	3	LC1F630		
	350	400	800	900	800	1000	1000	3	LC1F800		
	350	400	900	—	1000	1000	1250	3	LC1F1000		
	—	450	900	900	780	1600	1350	3	LC1F780		
	 <p>LC1700, F2100</p>	Current Rated					1400	1400	3	LC1F1400	
							1700	1700	3	LC1F1700	
2100							2100	3	LC1F2100		

Table 18.30: TeSys F Coil Voltage Codes [19]

Contactor	F115–F150	F185–F225	F265–F330	F400	F500	F630	F780[20]	F800[21]	F1400–F2100 [21]
Coil Suffix Code AC 50/60 Hz	G7	G7	G7	G7	G7	G7	G7	FW	G7
Coil Part Number (Order Separately) AC 50/60 Hz	LX9FF127	LX9FG127	LX1FH1272	LX1FJ127	LX1FK127	LX1FL100	LX1FX110	LX4F8FW	LX1FK070[22]
120 V	LX9FF220	LX9FG220	LX1FH2402	LX1FJ240	LX1FK240	LX1FL220	LX1FX220	LX4F8MW	LX1FK127[22]
240 V	LX9FF500	LX9FG500	LX1FH5002	LX1FJ500	LX1FK500	LX1FL415	LX1FX415	—	LX1FK240[22]
480 V	—								
Coil Part Number (Order Separately) DC[23]	LX4FF024	LX4FG024	LX4FH024	—	—	—	—	—	—
24 V	—								

TeSys™ F Overload Relays

Table 18.31: TeSys F 3-Phase Overload Relays—Solid State, Separate Mounting [24]

Current Setting Range A	For Direct Mounting to Contactor LC1••••	Class 10 Catalog Number	Class 20 Catalog Number	Class 10/20 Selectable Catalog Number
30–50	F115–F185	LR9F5357	LR9F5557	LR9F57
48–80	F115–F185	LR9F5363	LR9F5563	LR9F63
60–100	F115–F185	LR9F5367	LR9F5567	LR9F67
90–150	F115–F185	LR9F5369	LR9F5569	LR9F69
132–220	F185[25]–F400	LR9F5371	LR9F5571	LR9F71
200–330	F225–F500	LR9F7375	LR9F7575	LR9F75
300–500	F330–F500	LR9F7379	LR9F7579	LR9F79
380–630	F400–F630, F800	LR9F7381	LR9F7581	—

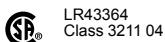
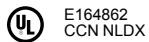

TeSys F contactor accessories: page 18-18
 TeSys F overload relay accessories: page 18-24
 TeSys F replacement coils and parts: page 18-41, page 18-40, and page 18-40
 TeSys F dimensions: page 18-45 and page 18-54

18 CONTACTORS AND STARTERS-IEC

[18] Complete the catalog number by adding the coil voltage code from Table 18.24 TeSys D Coil Voltage Codes, page 18-11 (for example, LC1F265G7), or order the contactor (without a coil) and the coil separately. All coils except F780 include 1 N.O. holding circuit interlock contact. The F780 uses two coils that must be wired in series.
 [19] For additional pole options and coil voltage options, see Catalog MKTED210011EN. Check with local sales office for availability.
 [20] LC1F780 contactors operate with 2 coils as a set. The LX1FX* part number includes both coils.
 [21] Also requires rectifier DR5TE4U for 110–240 V coils.
 [22] Order 2 coils and connect them in series.
 [23] DC coils for 3-pole contactors are fitted with built-in surge suppression as standard.
 [24] When mounting overload relays LR9F5•57–LR9F5•71 and LR9F57–LR9F71 directly beneath the contactor, supporting the relays with a mounting plate is recommended. With overload relays LR9F7•–LR9F7•81 and LR9F75–LR9F81, use of a support mounting plate is mandatory. Refer to page 18-24
 [25] Interconnection kit LA7F407 is required to mount an LR9F5•71 and LR9F71 to an LC1F185.

TeSys™ F Reversing Contactors

Components are available for customer assembly of TeSys F reversing contactors. For example, the following components must be ordered to build a reversing contactor, 75 hp @ 460 V, with a 120 V / 60 Hz coil:



LC1F265

Table 18.32: Example of Components

Description	Quantity	Catalog Number
Contactors	2	LC1F115G7
Lugs (page 18-22)	6	DZ2FF1
Auxiliary contacts	2	LADN11
Power connections	1	LA9FF976
Mechanical interlock	1	LA9FF970

Table 18.33: 3-Pole Contactors

Maximum Three-Phase Horsepower Ratings				Maximum Current (A)		Continuous Current Rating (A)	Holding Circuit Contact Built Into Coil		Catalog Number [26]
200 V	230 V	460 V	575 V	Inductive AC3	Resistive AC1		N.O.	N.C.	
30	40	75	100	115	200	175	1	0	LC1F115
40	50	100	125	150	250	200	1	0	LC1F150
50	60	125	150	185	275	200	1	0	LC1F185
60	75	150	150	225	315	250	1	0	LC1F225
60	75	150	200	265	350	285	1	0	LC1F265
75	100	200	250	330	400	370	1	0	LC1F330
100	125	250	300	400	500	420	1	0	LC1F400
150	200	400	500	500	700	700	1	0	LC1F500
250	300	600	800	630	1000	1000	1	0	LC1F630
350	400	800	900	800	1000	1000	0	0	LC1F800
—	450	900	900	780	1600	1350	0	0	LC1F780

Table 18.34: Auxiliary Contact (Electrical Interlocking)—2 must be purchased

For use with	Number of Contacts	Maximum Number of Blocks Per Contactor	Contact Arrangement		Catalog Number
			N.O.	N.C.	
LC1F to be ordered separately	1	1	1	—	LADN10 [27]
			—	1	LADN01
	2	2	1	1	LADN11
			2	—	LADN20 [27]
	4	2	2	2	LADN22
			1	3	LADN13
			4	—	LADN40 [27]
			—	4	LADN04
			3	1	LADN31
			2	2	LADC22 [28]

Table 18.35: Accessories—For the Assembly of 3-Pole Reversing Contactors (Horizontal Mounting)

With 2 Identical Contactors [29]	Set of Power Connections Catalog Number	Horizontal Mounting Mechanical Interlock Kit Catalog Number
LC1F115	LA9FF976	LA9FF970
LC1F150	LA9F15076	LA9FF970
LC1F185	LA9FG976	LA9FG970
LC1F225	LA9F22576	LA9FG970
LC1F265	LA9FH976	LA9FJ970
LC1F330	LA9FJ976	LA9FJ970
LC1F400	LA9FJ976	LA9FJ970
LC1F500	LA9FK976	LA9FJ970
LC1F630, F800	LA9FL976	LA9FL970

TeSys F contactor accessories: page 18-18
 TeSys F overload relay accessories: page 18-24
 TeSys F replacement coils and parts: page 18-41, page 18-40, and page 18-40
 TeSys F dimensions: page 18-45



E164862
CCN NLDX



LR43364
Class 3211 04



[26] Complete the catalog number with the coil voltage code from and (for example, LC1F115G7). All coils except F780 include 1 N.O. holding circuit interlock contact. The F780 uses 2 coils that must be wired in series.
 [27] Cannot be used for interlocking.
 [28] Including 1 N.O. + 1 N.C. make-before-break overlapping contacts.
 [29] For two contactors of different size, refer to page 18-22.

TeSys™ K Contactors

Table 18.36: Instantaneous Auxiliary Contact Blocks^[1]



Clip-on front mounting, 1 block per contactor and 2 blocks per pair of mechanically interlocked contactors			
Type of connection	Auxiliary Contacts		Catalog Number
	N.O.	N.C.	
Screw clamp	2	—	LA1KN20
	—	2	LA1KN02
	1	1	LA1KN11
	4	—	LA1KN40 [2]
	3	1	LA1KN31 [2]
	2	2	LA1KN22 [2]
	1	3	LA1KN13 [2]
	—	4	LA1KN04 [2]

Table 18.37: Electronic Time Delay Auxiliary Contact Blocks

Clip-on front mounting, 1 block per contactor and 2 blocks per pair of mechanically interlocked contactors				
Voltage (V)	Type	Timing Range (S)	Contacts	Catalog Number
24–48 Vac or Vdc	On-delay	1–30	SPDT	LA2KT2E
110–240 Vac	On-delay	1–30	SPDT	LA2KT2U

NOTE: Relay outputs, with single pole double throw, 240 Vac/Vdc, 2 A max.
Maximum switching capacity 250 VA / 150 W
Operating temperature: –10 to +60°C (14 to 140°F)
Reset time: 1.5 s during time delay, 0.5 after time delay

Table 18.38: Suppressor Module with Incorporated LED Indicator



Clip-on front mounting			
Voltage range	Type	Sold in lots of	Catalog Number
12–24 Vac/Vdc	Varistor	5	LA4KE1B [3]
32–48 Vac/Vdc	Varistor	5	LA4KE1E [3]
50–129 Vac/Vdc	Varistor	5	LA4KE1FC [3]
130–250 Vac/Vdc	Varistor	5	LA4KE1UG [3]
12–24 Vdc	Diode + Zener	5	LA4KC1B [4]
32–48 Vdc	Diode + Zener	5	LA4KC1E [4]
220–250 Vac	RC	5	LA4KA1U [5]

Table 18.39: Power Connectors

Description	Sold in lots of	Catalog Number
Set of 6 power connections for reversing contactors with screw-clamp terminals	100	LA9K0969

Table 18.40: Accessories for Overload Relays

Description	Type of Connection	Catalog Number
Terminal block for separate clip-on mounting of the overload relay onto 35 mm omega rail (AM1DP200)	Screw-clamp	LA7K0064



[1] For additional terminal options, see Catalog MKTED210011EN. Check with local sales office for availability.
[2] Block of 4 contacts cannot be used with LP4K or LP5K contactors.
[3] Protection by limitation of the transient voltage to 2 Uc maximum. Maximum reduction of the transient voltage peaks. Slight time delay on drop-out (1.1–1.5 times normal).
[4] No overvoltage or oscillation frequency. Polarized component. Slight time delay on drop-out (1.1–1.5 times normal).
[5] Protection by limitation of the transient voltage to 3 Uc maximum and limitation of the oscillation frequency. Slight time delay on drop-out (1.2 times normal).



Front Mounted Auxiliary Blocks

TeSys™ D and F Auxiliary Contacts, Time Delay, Mechanical Latch

Table 18.41: Standard, Instantaneous Auxiliary Contact Blocks

Snap-On Mounting	Number of Contacts	Contact Arrangement		Catalog Number [6]
		N.O.	N.C.	
To the front of LC•DT20–D258 (4P), LC•D09–D150 [6] or To the right side of LC•F	4 [6]	2	2	LADN22 [7]
		1	3	LADN13 [7]
		4	0	LADN40 [7]
		0	4	LADN04 [7]
	2	3	1	LADN31 [7]
		2	2	LADC22 [7] [8]
		1	1	LADN11 [7]
To the front of LC•D80–D150 or To the left side of LC•F	1	2	0	LADN20 [7]
		0	2	LADN02 [7]
	1	0	LADN10 [9]	
To the side of LC•D09 to D150 only (not for use on TeSys F)	2	1	1	LAD8N11 [10]
		2	0	LAD8N20 [10]

Table 18.42: Instantaneous Blocks with Dust-Tight Auxiliary Contacts (IP54) NEMA 12

Snap-On Mounting	Standard Contacts		Dust-Tight Contacts		Catalog Number
	N.O.	N.C.	N.O.	N.C.	
To the front of LP•D40–D80, LC•DT20–D258 (4P), LC•D09 to D95 or To the right side of LC•F	—	—	2	—	LA1DX20
	2	—	2	—	LA1DZ40
	1	1	2	—	LA1DZ31
—	—	—	2	—	LA1DY20 [11]

Table 18.43: Pneumatic Time Delay Contact Blocks

Snap-On Mounting	Time Delay Contacts		Type	Range of Time Delay	Catalog Number [12]
	N.O.	N.C.			
To the front of LP•D40–D80, LC•DT20–D258 (4P), LC•D09 to D150 or To the right side of LC•F	1	1	On energization (on delay)	0.1 to 3 s [13]	LADT0
				0.1 to 30 s	LADT2
				10 to 180 s	LADT4
	1	1	On de-energization (off-delay)	1 to 30 s [14]	LADS2
				0.1 to 3 s [13]	LADR0
				0.1 to 30 s	LADR2
—	—	—	10 to 180 s	LADR4	

Table 18.44: Mechanical Latch Blocks with Manual or Electrical Unlatch (TeSys D only)

Front snap-on mounting onto	Application	Catalog Number [15]
LC•D09 to D65A	For silent operation and energy conservation	LAD6K10 [16][17]
LC1D80 to D150, LP1D80	For silent operation and energy conservation	LA6DK20 [16]

Table 18.45: Coil Voltage Codes for LAD6K/LA6DK Mechanical Latch Blocks

Volts	24	110/ 127	220/ 240
AC or DC	B	F	M

TeSys D contactors: [page 18-11](#) and [page 18-13](#)
TeSys D overload relay accessories: [page 18-23](#)
TeSys D replacement coils: [page 18-40](#)
TeSys D dimensions: [page 18-42](#) to [page 18-52](#)



[6] For low consumption coils (LC1D09–D38 only), only one front-mounted two-contact block allowed. No side-mounted contact blocks allowed.
[7] For spring terminal versions of these blocks, add a 3 to the end of the catalog number (for example, LADN223). For slip-on versions, add 9 to the end of the catalog number (for example, LADN229).
[8] Including 1 N.O. + 1 N.C. make-before break overlapping contacts.
[9] This block cannot be added to the LC1D 09–D38 contactors; a maximum of 2 blocks can be mounted on the LC1D40A-LC1/LP1D80 contactors only.
[10] 1 block may be added to the left side of LC1D09–D38, AC coils only; only 1 block may be added to either side of the LC1D40A-D80 contactors, AC coils only. Cannot be installed on TeSys D contactors with DC coils.
[11] Device supplied with 4 ground terminal points.
[12] For spring terminal versions of these blocks, add a 3 to the end of the catalog number (for example, LADT23).
[13] Scale range is expanded between 0.1 and 0.6 seconds on the dial for more accurate settings at the lower end of the range.
[14] Switching time between the opening of the N.C. contact and the closing of the N.O. contact: 40 ms ± 15 ms.
[15] To complete the catalog number, add the coil voltage code from Table 18.45. For additional voltage options, see Catalog MKTED210011EN. Check with local sales office for availability.
[16] Does not include internal coil clearing contact.
[17] Low consumption DC contactors (and relays) (code coil •L) are not compatible with the LAD6K10• mechanical latching blocks.

TeSys™ D and F Accessories [18]

Table 18.46: For Power Pole or Control Connection

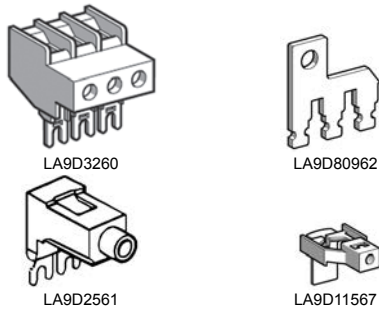

Description		For use with contactors LC1/LP1	Sold in lots of	Catalog Number
Connectors for larger cable sizes	3 poles #4 AWG (25 mm ²)	D09–D38	1	LA9D3260
Everlink™ terminal block	3 poles	D40A–D65A	1	LAD96560
Links for the parallel connection of:	3 poles (wye-delta shorting strap)	D09–D38	10	LAD9P3
		D40A–D65A	1	LAD9P33
		D80, D95	1	LA9D80962
		F115	1	LA9FF601
		F150, F185	1	LA9FG601
		F225, F265, F330, F400	1	LA9FH601
		F500	1	LA9FK601
		F500	1	LA9D8067
Control circuit take-off from main pole		D80, D95	10	LA9D8067
		D115, D150	10	LA9D11567
Replacement power terminal block		D115, D150	1	LA9D115603
Plunger (fire pump accessory)		D09–150	—	LAD9FP3

Table 18.47: For Marking

Description		For use with contactors LC1/LP1	Sold in lots of	Catalog Number
Reference label holder	Snap-on, 8 x 22 mm	4-pole contactors D80–D115	100	LA9D92
	Snap-on, 8 x 18 mm, 3 poles	D09–D65A, DT20–DT80A, LADN, LADT, LADR	100	LAD90
Sheet of 300 labels self adhesive, 7 x 21 mm		For holder LA9D92	1	LA9D93

Table 18.48: For Mounting

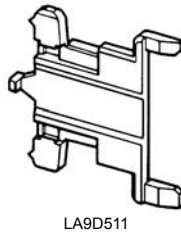

Description		For use with contactors LC1/LP1	Sold in lots of	Catalog Number
Set of shims for mounting LAD8N and LA8DN		D80–D95	1	LA9D511
Retrofit plate for replacing LC1D40–D65 with LC1D40A–D65A		D40A–D65A	1	LAD7X3
35 mm DIN Rail — 2 m		LC1D09–D80	10	AM1DP200

Table 18.49: Replacement Contacts

		For use with contactors		Catalog Number
Three-pole		LC1D115	3 poles	LA5D1158031
		LC1D150	3 poles	LA5D150803
Four-pole		LC1D115	4 poles	LA5D115804

Table 18.50: Arc Chambers

		For use with contactors		Catalog Number
Three-pole		LC1D115	3 poles	LA5D11550
		LC1D150	3 poles	LA5D15050
Four-pole		LC1D115	4 poles	LA5D115450

TeSys D contactors: [page 18-11](#) and [page 18-13](#)
 TeSys D overload relay accessories: [page 18-23](#)
 TeSys D contactor accessories: [page 18-17](#)
 TeSys D replacement coils: [page 18-40](#)
 TeSys D dimensions: [page 18-42](#) to [page 18-52](#)
 TeSys F contactors: [page 18-14](#) and [page 18-15](#)
 TeSys F replacement coils and parts: [page 18-41](#), [page 18-40](#), and [page 18-40](#)

[18] For additional accessory and replacement part options, see Catalog MKTED210011EN. Check with local sales office for availability.

RC and Varistor Coil Suppressors

RC Coil Suppressor



LA4DA1U

- Limitation of transient voltage to 300% of nominal voltage maximum.
- Oscillating frequency limited to 400 Hz maximum. Slight increase in drop-out time (1.2–2 times normal).

Table 18.51: Resistor/Capacitor Circuit (RC) for Reduction of Electrical Noise in AC Contactor Coils

Installed by	Mounting on	Operating Voltage 50/60 Hz	Catalog Number
Snapping into the cavity on the right side without tools [19]	LC•D09–D38 (3P), LC1DT20–DT40 (4P)	24–28 Vac	LAD4RCE
		50–127 Vac	LAD4RCG
		110–240 Vac	LAD4RCU
Snap-on mounting, and connection without tools to the contactor coil terminals	LC1D40A–65A (3P), LC1DT60A–DT80A (4P)	24–48 Vac	LAD4RC3E
		50–127 Vac	LAD4RC3G
		110–240 Vac	LAD4RC3U
		380–415 Vac	LAD4RC3N
Screw connection to the contactor coil terminals	LC•D80–D150 (3P), LC1D80–D115 (4P)	24–48 Vac	LA4DA2E
		50–127 Vac	LA4DA2G
		110–240 Vac	LA4DA2U
		380–415 Vac	LA4DA2N

Varistor Coil Suppressor [20]

- Limitation of transient voltage value to 200% of nominal voltage maximum.
- Maximum reduction of transient voltage peaks. Slight increase in drop-out time (1.1–1.5 times normal).

Table 18.52: Varistor (Peak Limiting) for Reduction of Electrical Noise in AC Contactor Coils

Installed by	Mounting on	Operating Voltage	Catalog Number
Snapping into the cavity on the right side without tools [19]	LC•D09–D38 (3P), LC1DT20–DT40 (4P)	24–48 Vac	LAD4VE
		110–250 Vac	LAD4VU
Snap-on mounting, and connection without tools to the contactor coil terminals	LC1D40A–D65A (3P), LC1DT60A–DT80A (4P)	24–48 Vac/Vdc	LAD4V3E
		110–250 Vac/Vdc	LAD4V3U
Screw connection to the contactor coil terminals	LC•D80–D115 (3P), LC1D80–D115 (4P)	24–48 Vac	LA4DE2E
		110–250 Vac	LA4DE2U
Screw connection to the contactor coil terminals	LC•D80–D95 (3P), LC1D80 (4P)	24–48 Vdc	LA4DE3E
		110–250 Vdc	LA4DE3U

Diode Coil Suppressor

- No overvoltage or oscillating frequency.
- Polarized component. Increased drop-out time (6–10 times normal).

Table 18.53: Diode for Reduction of Electrical Noise in DC Contactor Coils

Installed on the upper part by	Mounting on	Operating Voltage, DC	Catalog Number
Snap-on mounting and connection w/o tools to the contactor coil terminals	LC•D09 to D38 (3P), LC1DT20 to DT40 (4P)	24–250 Vdc	LAD4DDL
Clip-on front mounting	LC•D40A to D65A (3P), LC1DT60A to DT80A (4P)	24–250 Vdc	LAD4D3U
Screw connection of wire to the contactor coil terminals	LC•D80 to D95 (3P), LC1D80 (4P)	24–250 Vdc	LA4DC3U



LA4DC3U

[19] Installing the suppressor into the cavity makes the electrical connection. Overall width of the contactor remains the same.

[20] For additional accessory and replacement part options, see Catalog MKTED210011EN. Check with local sales office for availability.

Bidirectional Diode Coil Suppressor

- Protection provided by limiting the transient voltage to 2 Uc max.
- Maximum reduction of transient voltage peaks

Table 18.54: Bidirectional Peak Limiting Diode^[21]

Installed by	Mounting on	Operating Voltage		Catalog Number
		Vac (50/60 Hz)	Vdc	
Snapping into the cavity on the right side of the contactor ^[22]	LC•D09–D38 (3P) ^[23]	24	—	LAD4TB
	LC1DT20–DT40 (4P)	—	24	LAD4TBDL
Clip-on front mounting and connection without tools to the contactor coil terminals ^[23]	LC•D40A–D65A (3P), LC1DT60A–DT80A (4P)	12–24	12–24	LAD4T3B
	LC•D80–D95 (3P), LC1D80 (4P)	—	24	LA4DB3B

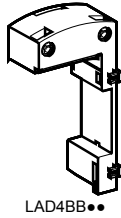

Table 18.55: Cabling Accessories^[21]

Usage	Mounting on	Operating Voltage 50/60 Hz	Catalog Number
For adapting existing wiring to a new product or for use with top-mounting accessory.	LC1D09–D38	Without coil suppression	LAD4BB
		With coil suppression (varistor)	LAD4BBVE
For adapting existing wiring to a new product or for use with top-mounting accessory	LC1D40A–D65A	24–48 Vac	LAD4BBVVG
		50–127 Vac	LAD4BBVVG
For adapting existing wiring to a new product or for use with top-mounting accessory	LC1D40A–D65A	Without coil suppression	LAD4BB3

TeSys D contactors: page 18-11 and page 18-13
 TeSys D contactor accessories: page 18-17
 TeSys D overload relay accessories: page 18-23
 TeSys D replacement coils: page 18-40
 TeSys D dimensions: page 18-42 to page 18-52

TeSys™ D Electronic Timers and Interface Modules

The following accessories require use of cabling accessories (LAD4BB••) for proper mounting. See page 18-20 for illustration.

Table 18.56: Electronic Serial Timer Modules

Type	Operational Voltage ^[25]		Time Delay	Catalog Number
	24–250 Vac	100–250 Vac		
On-delay	LC1D09–D65A	LC1D80–D150	0.1–2 s	LA4DT0U
			1.5–30 s	LA4DT2U
			25–500 s	LA4DT4U



Table 18.57: Interface Modules^[21]

Interface Type ^[26]	Operational Voltage		Input Voltage	Catalog Number
	24–250 Vac	100–250 Vac		
Relay	LC1D09–D150	—	24 Vdc	LA4DFB
Solid State	LC1D09–D65A	LC1D80–D115	24 Vdc	LA4DWB



Table 18.58: TeSys Safety-Chain Identification System^{New!}

Description	Compatibility	Package Qty	Catalog Number
Red retrofit contactor safety cover	LC1D09–D65A, CAD32, CAD50	10	LAD9ET1S
	LC1D80	1	LAD9ET3S
	LC1D115–D150	1	LAD9ET4S
Red auxiliary contact block, 2 N.O. + 2 N.C.	LC1D09–D150, CAD32, CAD50	1	LADN22S
Red retrofit safety sticker	TeSys U	10	LU9ET1S

[21] For additional voltage and accessory options, see Catalog MKTED210011EN. Check with local sales office for availability.

[22] Installing the suppressor into the cavity makes the electrical connection. Overall width of the contactor remains the same.

[23] For LC•D09–LC•D65A with DC or low consumption DC coils, 3–pole contactors are fitted with built-in bidirectional diode suppression as standard.

[24] Mounting at the top of the contactor on coil terminals A1 and A2.

[25] For 24 V operation, the contactor must be fitted with a 21 V coil: coil voltage code Z5 for 50 Hz; Z6 for 60 Hz; and ZD for DC.

[26] Adapter required for D09–D65A, see .

TeSys™ D Reversing Contactors

Table 18.59: Components and Kits for Reversing Assemblies^[27]

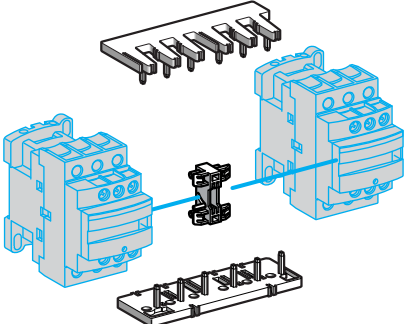
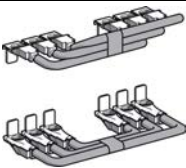
	Description		For contactor (2 identical contactors)	Part Number
Kits for Assembly of Reversing Contactors				
 <p>LAD 9R1</p>	Kit comprising of: <ul style="list-style-type: none"> • Mechanical interlock • Electrical wiring links • Power wiring links 		LC1 D09 to D38	LAD9R1V
			LC1 DT20 to DT40	LADT9R1V
 <p>LA9 D8069</p>	Kit comprising of: <ul style="list-style-type: none"> • Mechanical interlock • Power wiring links 		LC1 D09 to D38	LAD9R1
			LC1 D40A to D65A	LAD9R3
	For Contactor (2 Identical Contactors)	Mechanical Interlock	Mechanical Interlock with Integral Electrical Interlocking	Reversing Power Links (Parallel and Reverser)
Components for Assembly of Reversing Contactors				
	LC1 D40A to D65A	LAD4CM	—	LA9D65A69
	LC1 D80 to D95 (AC coil)	LA9D50978	LA9D4002	LA9D8060
	LC1 D80 to D95 (DC coil)	LA9D60978	LA9D8002	LA9D8060
	LC1 D115 to LC1D 150	—	LA9D11502	LA9D11569

TeSys D contactors: [page 18-11](#) and [page 18-13](#)
 TeSys D contactor accessories: [page 18-17](#)
 TeSys D replacement coils: [page 18-40](#)
 TeSys D dimensions: [page 18-42](#) to [page 18-52](#)

[27] For additional reversing accessory options, see Catalog [MKTED210011EN](#). Check with local sales office for availability.

TeSys™ F Reversing Contactors [28]

Table 18.60: Component Parts for the Assembly of F-Line 3-pole Reversing Contactors

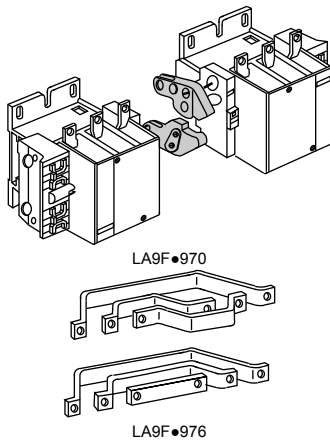

With 2 Identical Contactors	Set of Power Connections Cat. No.	Mechanical Interlock Kit Cat. No.
Horizontal Mounting		
LC1F115	LA9FF976	LA9FF970
LC1F150	LA9F15076	LA9FF970
LC1F185	LA9FG976	LA9FG970
LC1F225	LA9F22576	LA9FG970
LC1F265	LA9FH976	LA9FJ970
LC1F330	LA9FJ976	LA9FJ970
LC1F400	LA9FJ976	LA9FJ970
LC1F500	LA9FK976	LA9FJ970
LC1F630 or F800	LA9FL976	LA9FL970

TeSys™ F Contactors

Table 18.61: Suppressor Blocks

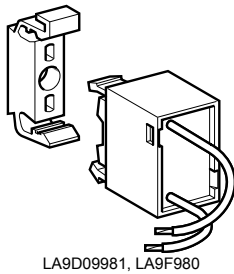

Operating limit: up to 220 V, 50/60 Hz coils		
Description	For Use with coils	Catalog Number
Suppressor block (clip-on mounting to coil)	LX1FH, F265, F330	LA9F980
	LX1FJ, FK, FL, FX, F400, F500, F630, F780, LX9FF, FG, FH, F115, F150, F185, F225, F265, F330	LA9D09980
Mounting bracket (for 35 mm DIN rail or panel mounting) for suppressor block		LA9D09981

Table 18.62: Lugs and Terminal Shrouds for TeSys F Contactors

Contactors Type LC1	Cable Size AWG Range	Lug Kit (Quantity of 6)	Individual Lug (Quantity of 1)
F115	14 to 2/0	DZ2FF6	DZ2FF1
F150, F185	6 to 3/0	DZ2FG6	DZ2FG1
F225, F265, F330	6 to 300 MCM	DZ2FH6	DZ2FH1
F400	4 to 500 MCM	DZ2FJ6	DZ2FJ1
F500	2 x 2 to 600 MCM	DZ2FK6	DZ2FK1
F630	3 x 2 to 600 MCM	DZ2FL6	DZ2FL [29]
F800	3 x 2 to 600 MCM	DZ2FL6	—
F780	4 x 1/0 to 750 MCM	DZ2FX6	—

Table 18.63: Lugs and Terminal Shrouds for TeSys F Contactor with TeSys F Overload Relay [30]

Contactors Type LC1	Overload Relay (Direct Mount to Contactor)	Contactors Line Side Lug (Qty)	Line Side Cable Size AWG Range	Overload Load Side Lug (Qty)	Load Side Cable Size AWG Range
F115	LR9F5•57–F5•69, LR9F57–F69	DZ2FF1 (3)	14 to 2/0	DZ2FG1 (3)	6 to 3/0
F150, F185	LR9F5•57–F5•71, LR9F57–F71	DZ2FG6 (1)	6 to 3/0	(included with line side lug kit)	6 to 3/0
F225, F265	LR9F5•71, LR9F71	DZ2FG6 (1)	6 to 300 MCM	(included with line side lug kit)	6 to 300 MCM
F265, F330	LR9F7•75–F7•79, LR9F75–F79	DZ2FH1 (3)	6 to 300 MCM	—	4 to 500 MCM
F400	LR9F7•75–F7•81, LR9F75–F81	DZ2FJ1 (3)	4 to 500 MCM	—	4 to 500 MCM
F500	LR9F7•75–F7•81, LR9F75–F81	DZ2FK1 (3)	2 X 2 to 600 MCM	—	4 to 500 MCM
F630	LR9F7•81, LR9F81	DZ2FL1 (1) DZ2FL2 (1) DZ2FL3 (1)	3 X 2 to 600 MCM	DZ2FR1 (1)	4 to 500 MCM

These clear plastic protective shrouds are an effective means to meet international touch-safe requirements for power terminals. They are designed to be used with power cables that have been bolted to the terminal.

NOTE: The protection shrouds do not attach to contactors or overloads using DZ2F lug kits.

[28] For additional reversing accessory options, see Catalog MKTED210011EN. Check with local sales office for availability.
 [29] For 2-pole F630 contactors, order two DZ2FL1 (L1 and T2), and two DZ2FL3 (L2 and T1). For 4-pole F630, order two DZ2FL1 (L1 and T4), four DZ2FL2 (L2, T2, L3, T3) and two DZ2FL3 (L4 and T1).
 [30] Lug kits ending in the number 6 include 6 identical lugs. In some cases the LR9F overload relay mounted directly on the load side of an LC1F contactor will require a different size lug for your choice of contactor and overload. If the two sizes are different, order 3 of each size lug. Mounting hardware (screws, washers, and nuts) are provided with the contactors and overload relays, not with the lugs.

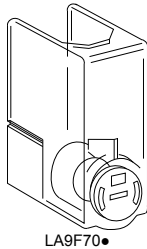

LA9F70•

Table 18.64: Power Terminal Protection Shrouds

For Use With 2-, 3-, And 4-pole Contactors	Number of Shrouds Per Set	Catalog Number
LC1F115	6	LA9F701
LC1F150, F185	6	LA9F702
LC1F225, F265, F330, F400 and F4002, F500 and F5002	6	LA9F703
LC1F630, F6302 and F800	6	LA9F704
LC1F1154	8	LA9F706
LC1F1504 and F1854	8	LA9F707
LC1F2254, F2654, F3304, F4004, F5004	8	LA9F708
LC1F6304	8	LA9F709

For contactors LC1F115, LC1F150, and LC1F185, an available touch-safe terminal block may be used in place of lugs for power connections.

Table 18.65: Insulated Terminal Blocks

For contactor type LC1	For overload relay LR9	Maximum Cable Size	Catalog Number
F115, F150, F185	F5•57, F5•63, F5•67, F5•69, F57, F63, F67, F69	300 MCM	LA9F103

TeSys F contactor accessories: page 18-18

TeSys F overload relay accessories: page 18-24

TeSys F replacement coils and parts: page 18-41, page 18-40, and page 18-40

TeSys F dimensions: page 18-45, page 18-54

TeSys D Overload Relay Accessories

Table 18.66: Mounting Kits and Plates^[1]

Description	For use with overload relays:	Cat. No.
Separate mounting kits for mounting to 35 mm DIN rail or for panel mounting with screws	LRD01–35 and LR3D01–35	LAD7B10
	LRD01–35 and LRD01–35 for ring tongue terminals	LAD7B106
	LRD04L–32L, LR3D04L–32L, and LR9D01–32	LAD7B205
	LRD3•••, LR3D3•••, LR2D35••	LAD96560



LA7D901

Table 18.67: Accessories

Description	For use with	Standard Package	Catalog Number
Prewiring kit allows direct connection of the N.C. contact of relay LRD01–D32 or LR3D01–D32 to the contactor	LC1D09 to D18	10	LAD7C1
	LC1D25 to D38	10	LAD7C2
Remote stop/tripping or electrical reset ^[2]	LRD01–D32, LRD3, LR3D01–D32, LR3D3	1	LAD703 ^[3]
	All relays except LRD01–D32, LR3D01–D31	1	LA7D03 ^[3]
Reset by flexible cable 500 mm (19.6 in.)	LRD01–D32, LRD3, LR3D3	1	LAD7305

Table 18.68: Control Circuit Voltages for LA7D03 and LAD703

Volts	24	110
AC 50/60 Hz	B	F
DC	B	F



LA7D03

[1] When using mounting plates, separate mounting kits are also required.

[2] The time that the LA7D03 can remain energized depends on its rest time; 1 s pulse with 9 s rest time; 5 s pulse with 30 s rest time; 10 s pulse with 90 s rest time; maximum pulse duration of 20 s with rest time of 300 s. Consumption on inrush and sealed: < 100 VA

[3] Part number to be completed by adding coil voltage code, (for example, LAD703F).

TeSys F Overload Relay Accessories

Table 18.69: Mounting Plate for Overload Relay



LA7F90

For use with relays	Catalog Number
LR9F5•57, F5•63, F5•67, F5•69, F5•71, F57, F63, F67, F69, and F71	LA7F901
LR9F7•75, F7•79, F5•81, F75, F79, and F81	LA7F902

These clear plastic protective shrouds are an effective means to meet international finger-safe requirements for power terminals. They are designed to be used with power cables that have been bolted to the terminal.

NOTE: Protection shrouds do not attach to contactors/overloads using DZ2F lug kits.

Table 18.70: Power Terminal Protection Shrouds, Single-Pole

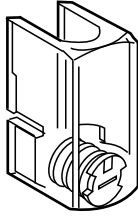

LA9F70

For use with relays	Catalog Number
LR9F5•57, F57	LA9F701
LR9F5•63, F5•67, F5•69, F63, F67, F69	LA9F702
LR9F5•71, F71	LA9F705
LR9F7•75, F7•79, F7•81, F75, F79, F81	LA9F703

Table 18.71: Power Terminal Protection Shrouds, 3-Pole



LA7F701

For use with relays	Catalog Number
LR9F5•57, F5•63, F5•67, F5•69, F57, F63, F67, F69	LA7F701
LR9F5•71, F71	LA7F702
LR9F7•75, F7•79, F7•81, F75, F79, F81	LA7F703

Table 18.72: Connection Accessories (for Mounting Overload Relays Beneath Reversing Contactors)^[4]

Application		Set of 3 Busbars Catalog Number
For relays	For contactor	
LR9F5•71, F71	LC1F185	LA7F407
LR9F5•71, F71	LC1F225 and F265	LA7F403
LR9F7•75, F5•79, F75, F79	LC1F225 to F400	LA7F404
LR9F7•81, F81	LC1F400	LA7F404
LR9F7•81, F81	LC1F630 and F800	LA7F406

TeSys D dimensions: [page 18-50](#) and [page 18-52](#)
 TeSys F dimensions: [page 18-45](#), [page 18-54](#)

[4] Mounting plate required.

TeSys™ U Motor Starter

The TeSys U motor starter is integrated, making it simple to choose and install. It consists of a control unit snapped in a power base. TeSys U can be configured to fit specific applications as well. Optional accessories include a reverser, a current limiter, predictive maintenance options, and communication options. For detailed information about TeSys U, visit our website.

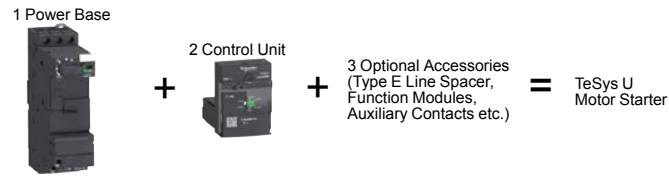

Selecting TeSys U Motor Starters in Three Steps

Table 18.73: Step 1. Select Power Base (Only two different bases up to 32 A)

Control Connection	Max. Current (A)	Maximum Horsepower Ratings						Self-Protected Starter Base
		Three-Phase			Single-Phase			
		200 V	230 V	460 V	575 V	115 V	230 V	Catalog Number
With non-removable screw terminations	12	3	3	7.5	10	0.5	2	LUB12
	32	10	10	20	25	2	5	LUB32
Without screw terminations	12	3	3	7.5	10	0.5	2	LUB120 [1]
	32	10	10	20	25	2	5	LUB320 [1]

Table 18.74: Step 2. Select Control Unit [2]

Setting Range (A)	Standard 3-phase Class 10 trip [3]	Advanced 3-phase Class 10 trip [3]	Advanced single-phase Class 10 trip [3]	Advanced 3-phase Class 20 trip [3]
0.15–0.6	LUCAX6●●	LUCBX6●●	LUCX6●●	LUCDX6●●
0.3–1.4	LUCA1X●●	LUCB1X●●	LUCX1X●●	LUCD1X●●
1.25–5.0	LUCA05●●	LUCB05●●	LUCX05●●	LUCD05●●
3–12	LUCA12●●	LUCB12●●	LUCX12●●	LUCD12●●
4.5–18	LUCA18●●	LUCB18●●	LUCX18●●	LUCD18●●
8–32	LUCA32●●	LUCB32●●	LUCX32●●	LUCD32●●

Table 18.75: Voltage Codes

Volts	24	110–240
DC	BL [4]	—
AC	B	—
DC or AC	—	FU

Table 18.76: Step 3. Select Auxiliary Contacts (optional)

Terminals	Contact Indicates	Contact Normal Status	Contact State for Each Mode [5]							Catalog Number
			Off	Ready	Run	Short Circuit Trip	Overload Trip (Manual Reset)	Overload Trip (Remote/Auto Reset) [6]		
Auxiliary Contact Blocks										
Screw	Ready condition	N.O.	O	I	I	O	O	I		LUA1C11
	Fault condition	N.C.	I	I	I	O	O	I		
Screw	Ready condition	N.O.	O	I	I	O	O	I		LUA1C20
	Fault condition	N.O.	O	O	O	I	I	O		
Auxiliary Contact Function Modules										
Screw	Pole state	2 N.O.	O	O	I	O	O			LUFN20
Screw	Pole state	1 N.O. and 1 N.C.	O I	O I	I O	O I	O I			LUFN11
Screw	Pole state	2 N.C.	1	I	O	I	I			LUFN02

Table 18.77: Accessories

Accessory	Quick Description	For details & selection, see:
Current limiter	Increases the breaking capacity to 130 kA @ 460 V and to 65 kA @ 575 V	page 18-27
Reverser	Stacked or side mounted (LU6MB0●●● only)	page 18-27
Line phase barrier	Required for use as a self-protected combination starter (UL 508 Type E)	page 18-27
Multifunction control unit	Has functions for monitoring and predictive maintenance	page 18-27
Function modules	Fault differentiation, thermal overload, motor load indication	page 18-27
Communication modules	Integrates into existing networks, major protocols are available	page 18-28
Soft starter + TeSys U	Use Altistart U01soft starter with TeSys U	page 18-39
Powerbus	Use TeSys U with a prewired system	page 18-28
Configuration and connection accessories	SoMove software, bus bar, external handle	page 18-28

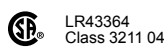

Accessories: page 18-26 to page 18-28
Dimensions: page 18-57
Overload Relays: page 18-9
Accessories: page 18-16
Dimensions: page 18-56

[1] For use with reversing modules or communication modules with prewired connector.
[2] The control unit contains solid-state overload relay and control power source for TeSys U. For more details on the different control units, their functions, and placement on the power base, see page 18-26.
[3] Complete the catalog number by adding appropriate code from Table 18.75 (for example, LUCAX6FU).
[4] DC voltage with range of 0.90 to 1.10 of nominal.
[5] I indicates closed contact; O indicates open contact.
[6] Requires multifunction or advanced control unit plus fault differentiation module LUFDA10.

Control Units and Functions

Table 18.78: Control Units and Functions

Reference	Standard LUCA	LUCB	Advanced LUCC	LUCD	Multifunction LUCM
Protection type					
Class 10					
Class 20					
Class 5-30					
Single Phase: LUCC Class 10 only					
Protection functions					
Short circuit					
Over current					
Thermal overload					
Phase loss					
Phase imbalance					
Ground fault					
Underload, long start, jam					
Control functions					
Manual reset					
Automatic or local/remote reset					
Fault differentiation					
Thermal alarm					
Motor load display					
Fault history					
Alarm threshold adjustment					
Tripping test					

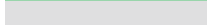
 = built-in the control unit
 = works with the related function modules (see page 18-27)

Power Base and Plug-in Accessories

See below where to install accessories on the power base. Only one accessory can be installed in each location.

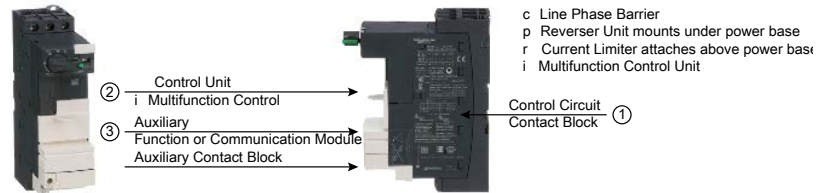

TeSys™ Reversing Starters

Table 18.79: Power Base with Reversing Unit assembled under the base

Control Connection	Max. Current (A)	Maximum Horsepower Ratings						Self-Protected Starter Base Catalog Number
		Three-Phase			Single-Phase			
		200 V	230 V	460 V	575 V	115 V	230 V	
With screw terminations	12	3	3	7.5	10	1.5	2	LU2B12 [7]
	32	10	10	20	25	2	5	LU2B32[7]



Line Phase Barrier



Reverser Unit Assembled under the Power Base

Table 18.80: Select Control Unit Options [8][9]

Setting Range (A)	Standard Three-Phase Class 10 trip [10]	Advanced Three-Phase Class 10 trip [10]	Advanced Single-Phase Class 10 trip [10]	Advanced Three-Phase Class 20 trip [10]
0.15–0.6	LUCAX6●●	LUCBX6●●	LUCCX6●●	LUCDX6●●
0.3–1.4	LUCA1X●●	LUCB1X●●	LUCC1X●●	LUCD1X●●
1.25–5.0	LUCA05●●	LUCB05●●	LUCC05●●	LUCD05●●
3–12	LUCA12●●	LUCB12●●	LUCC12●●	LUCD12●●
4.5–18	LUCA18●●	LUCB18●●	LUCC18●●	LUCD18●●
8–32	LUCA32●●	LUCB32●●	LUCC32●●	LUCD32●●

Table 18.81: Voltage Codes

Volts	24	110–240
DC	BL [11][12]	—
AC	B	—
DC or AC	—	FU

Table 18.82: Reversing Modules for Field Addition

Mounting	Catalog No.	Wiring Adapter	
Beneath	LU2MB0	LU9MR1C	Note: For LU2MB0 and LU6MB0, voltage code required; must match control unit.
Beside	LU6MB0	LU9MR1	

TeSys™ U Accessories

Table 18.83: Current Limiter [13][14]

Accessory	Application	Technical Data	Mounting	Cat. No.
Current limiter/isolator	Additional current limiting aspects for the starter	130 kA at 460 V 65 kA at 575 V	Direct mounting to LUB● and LU2B●	LUALB1
Limiter cartridge	Replacement cartridge for LUALB1	130 kA at 460 V 65 kA at 575 V	—	LUALF1

Table 18.84: Function Modules [13][15]

Module	Description	For use with:	Operation Requirements	Catalog Number
Fault differentiation: with manual reset (thermal overload) with auto reset	Provides indication between an overload trip and a short circuit trip.	Advanced control units only	24–250 Vac/Vdc (power from control unit)	LUFDA10
Thermal overload pre-alarm	Signals when the motor current reaches 1.05 of the full load setting on the control unit.	Advanced control units only	24–250 Vac/Vdc (power from control unit)	LUFW10
Motor load indication	Provides a signal proportional to the average currents in the three phases divided by the full load current setting of the control unit. The output corresponds to a load status of 0–2 times the full load setting of the control unit.	Advanced or multi-function control units	4–20 mA (requires separate 24 Vdc power supply)	LUFV2
Parallel wiring	Provides a convenient way to reduce control wiring and allow for connecting starters to a communications network by providing 24 Vdc for the starters.	Advanced or multi-function control units (24 Vdc only) and LU9BN11C or LU9MRC prewired connector	LU9G02 splitter box and PLC network	LUFC00



Alarm Differentiation



Parallel Wiring



Motor Load Indicator

[7] Voltage code required.

[8] The control unit contains solid-state overload relay and control power source for TeSys U. For more details on the different control units, their functions, and placement on the power base see page 18-26.

[9] Control units for 4.5–18 and 8–32 can be used **only** with 32 A rated power bases (LUB32, LUB320, and LU2B32).

[10] Complete the catalog number by adding the appropriate code from (for example LUCAX6FU).

[11] DC voltage with range of 0.90 to 1.10 of nominal.

[12] Voltage code to use for a power base with a communication module.

[13] See page 18-26 for placement on the power base.

[14] Increases the breaking capacity of the motor starter.

[15] Offers customization for specific application requirements.

Accessories

Table 18.85: Communication Modules [16][17]

Communication modules allow the TeSys U starter to be connected directly to the network. They are for use with advanced or multi-function control units (24 Vdc only) and require a separate 24 Vdc power supply.



Module	Prewired Connector	Catalog Number
Modbus™ Communication	LU9BN11C or LU9MRC	LULC033
CANopen Communication	LU9BN11L or LU9MRL	LULC08
Profibus Communication	LU9BN11L or LU9MRL	LULC07
DeviceNet™ Communication	LU9BN11L or LU9MRL	LULC09

Table 18.86: TeSys U Cabling Accessories—Power Bus Bars

Description	Application	Pitch	Standard Pack	Catalog Number
3-Pole, 63 A Bus Bar	For feeding 2 TeSys U controllers	45	1	GV2G245
		54	1	GV2G254
		72	1	GV2G272
	For feeding 3 TeSys U controllers	45	1	GV2G345
		54	1	GV2G354
	For feeding 4 TeSys U controllers	45	1	GV2G445
		54	1	GV2G454
		72	1	GV2G472
	For feeding 5 TeSys U controllers	54	1	GV2G554
	Terminal blocks	Top feed for use with bus bars	—	1

Table 18.87: Control Circuit Accessories [16]

Accessory	Application	Technical Data	Mounting	Catalog Number
Control circuit contact block	Switches control circuit power via LUB● handle (NEC430-74 compliance)	5 A at 600 Vac 5 A at 250 Vdc	Side mounting to LUB● and LU2B● only	LUA8E20
Through-the-door operating mechanism (without trip indication)	Use to enclose TeSys LUB● only.	NEMA 1, 12, 3R, 4, 4X Red/Yellow	Kit	LU9APN44
Control circuit filters	Use with electronic or triac output controllers	Up to 150 Vac max.	Directly to coil terminals	Non-reversing LUA4F11 Reversing LUA4F12
Pre-wired connector	Central control when using communication modules	See Table 18.85 for usage.	Lower power terminals to communication module.	Non-reversing LU9BN11C LU9BN11L Reversing LU9MRL

[16] See page 18-26 for placement on the power base.

[17] Communication capabilities can be integrated into existing automation architecture via a variety of protocols.

TeSys H™ Ultra Compact Starters

TeSys H ultra compact motor starters are extremely compact motor starters for asynchronous motors (AC53a utilization category) and resistive loads (AC51 utilization category). With up to 75% space savings, the 22.5 mm wide starter maintains that width even for a reversing starter! An available safety version features embedded Safe Torque Off and is SIL3 according to IEC 61508-1 and Ple according to ISO 13849-1. TeSys H is ideal for industries such as food and beverage, logistics, and durable goods. For selection, see Catalog [MKTED210011EN](#). Check with local sales office for availability.



TeSys H™ Ultra Compact Starter

TeSys™ GV Family

The TeSys GV family of products provide efficient motor control and protection solutions up to 520 amps. There are a variety of UL approved applications that enable specified configurations for use as a manual starter, motor disconnect, independent branch short-circuit protection, motor overload protection, or for use with a motor controller such as a contactor to build a complete motor control circuit. Certain configurations are approved for group motor applications as well. Refer to the following selection tables for application information, as well as the Motor Control Solutions for the North American Market data bulletin (8536DB0901) for additional information.

The TeSys GV2P (up to 32 amps) and GV3P (up to 65 amps) is rated to UL 60947-4-1 as a motor starter, and also possess Type E ratings for manual switching applications. These devices can be combined with a specified TeSys D contactor as a Type F combination motor controller (with specified line side spacer/accessories), with SCCR up to 100kA.

The TeSys GV2ME (up to 32 amps) combined with a specified TeSys D contactor is ideal for group motor applications.

The TeSys island load management starters are approved for use with TeSys GV2P and GV3P devices as a group motor arrangement. See selection table for application specifics.

The TeSys GV4PB, GV5PB, and GV6PB are motor protective circuit breakers rated to UL 489, are approved as branch circuit protection (no line side spacer required) and include motor overload protection. A full motor branch circuit is completed with the addition of a contactor, providing a compact two-component solution up to 520 motor full load amps. Pre-trip alarm accessories can be applied to these units to help anticipate and resolve issues, minimizing operator or maintenance interaction.



GV2P



GV4PB

Table 18.88: GV2, GV3 Manual Motor Protectors (UL 60947-4-1)

	Thermal Setting (A)	Maximum Horsepower Ratings								GV2ME push button ^[18]	GV2/3P rotary handle		
		Single-Phase			Three-Phase							Catalog Number	Catalog Number
		115 V	200 V	230 V	115 V	200 V	230 V	460 V	575 V				
	0.10–0.16	—	—	—	—	—	—	—	—	—	GV2ME01	GV2P01	
	0.16–0.25	—	—	—	—	—	—	—	—	—	GV2ME02	GV2P02	
	0.25–0.40	—	—	—	—	—	—	—	—	—	GV2ME03	GV2P03	
	0.40–0.63	—	—	—	—	—	—	—	—	—	GV2ME04	GV2P04	
	0.63–1	—	—	—	—	—	—	—	—	1/2	GV2ME05	GV2P05	
	1–1.6	—	—	1/10	—	—	—	3/4	3/4	—	GV2ME06	GV2P06	
	1.6–2.5	—	1/6	1/6	—	1/2	1/2	1	1.5	—	GV2ME07	GV2P07	
	2.5–4	1/8	1/4	1/3	—	3/4	3/4	2	3	—	GV2ME08	GV2P08	
	4–6.3	1/4	1/2	1/2	3/4	1	1.5	3	5	—	GV2ME10	GV2P10	
	6–10	1/2	1	1.5	1	2	3	5	7.5	—	GV2ME14	GV2P14	
	9–14	3/4	2	2	2	3	3	10	10	—	GV2ME16	GV2P16	
	13–18	1	2	3	2	5	5	10	15	—	GV2ME20	GV2P20	
	17–23	1.5	3	3	3	5	7.5	15	20	—	GV2ME21	GV2P21	
	20–25	2	—	—	—	7.5	7.5	15	20	—	GV2ME22	GV2P22	
	24–32	2	5	5	5	7.5	10	20	25	—	GV2ME32	GV2P32	
	9–13	1/2	—	1.5	—	3	3	7.5	10	—	—	GV3P13	
	12–18	3/4	—	2	—	3	5	7.5	10	—	—	GV3P18	
	17–25	1.5	—	3	—	5	7.5	15	20	—	—	GV3P25	
	23–32	2	—	3	—	7.5	7.5	20	25	—	—	GV3P32	
	30–40	3	—	5	—	10	10	25	30	—	—	GV3P40	
37–50	3	—	7.5	—	10	10	30	40	—	—	GV3P50		
48–65	3	—	10	—	15	15	40	50	—	—	GV3P65		

[18] For spring terminals add 3 to the catalog number (for example, GV2ME013). GV2ME013 is not available with spring terminals. For ring terminals, add 6.



GV4PB



GV5PB



GV2P10 with LC1D09

Table 18.89: GV4, GV5, GV6 UL 489 Motor Protective Circuit Breakers

Motor FLA Dial Range	Interrupting Rating: 240 V ... 35 kA 480Y/277 V ... 18 kA 600Y/347 V ... 14 kA	Interrupting Rating: 240 V ... 65 kA 480Y/277 V ... 35 kA 600Y/347 V ... 18 kA	Interrupting Rating: 240 V ... 100 kA 480Y/277 V ... 65 kA 600Y/347 V ... 25 kA
0.8 ... 2	—	GV4PB02N	GV4PB02S
1.4 ... 3.5	—	GV4PB03N	GV4PB03S
2.9 ... 7	—	GV4PB07N	GV4PB07S
5 ... 12.5	—	GV4PB12N	GV4PB12S
10 ... 25	GV4PB25B	GV4PB25N	GV4PB25S
20 ... 50	GV4PB50B	GV4PB50N	GV4PB50S
40 ... 80	GV4PB80B	GV4PB80N	GV4PB80S
65 ... 115	GV4PB115B	GV4PB115N	GV4PB115S
58 ... 130	—	GV5PB150N	GV5PB150S
114 ... 217	—	GV5PB250N	GV5PB250S
190 ... 348	—	GV6PB400N	G65PB400S
312 ... 520	—	GV6PB600N	G65PB600S

GV2P + LC1D Pre-Assembled Kits

Simplify your life! These new **pre-assembled kits** come with a GV2P manual motor protector already connected to an LC1D contactor. Panel builders and end users can now save wiring time by purchasing the pre-assembled kits.

Table 18.90: Pre-Assembled Kits ^{New!}

Components (includes GV2AF3)	UL File E134347 SCCR Type F 480Y/277V		Group Motor Rating UL File E89451 SCCR 480 V	Kit Part No. [19]
	With GV2GH7 or GV1G09 Line Side Adapter	With GV1G09 Line Side Adapter and GV2G Busbar		
GV2P02 + LC1D09G7	100 kA	100 kA	22 kA	GV2P02KD09
GV2P03 + LC1D09G7	100 kA	100 kA	22 kA	GV2P03KD09
GV2P04 + LC1D09G7	100 kA	100 kA	22 kA	GV2P04KD09
GV2P05 + LC1D09G7	100 kA	100 kA	22 kA	GV2P05KD09
GV2P06 + LC1D09G7	100 kA	100 kA	22 kA	GV2P06KD09
GV2P07 + LC1D09G7	100 kA	100 kA	22 kA	GV2P07KD09
GV2P08 + LC1D09G7	100 kA	100 kA	22 kA	GV2P08KD09
GV2P10 + LC1D09G7	100 kA	100 kA	22 kA	GV2P10KD09
GV2P14 + LC1D09G7	100 kA	100 kA	22 kA	GV2P14KD09
GV2P16 + LC1D25G7	50 kA	42 kA	22 kA	GV2P16KD25
GV2P20 + LC1D25G7	50 kA	42 kA	22 kA	GV2P20KD25
GV2P21 + LC1D25G7	50 kA	42 kA	22 kA	GV2P21KD25
GV2P22 + LC1D25G7	50 kA	42 kA	22 kA	GV2P22KD25

Coil Voltage Suffix	
120 Vac	G7
24 Vac	B7
24 Vdc Low Consumption	BL

[19] Complete the catalog number with the coil voltage suffix (for example GV2P16KD25G7).

TeSys BV4 Motor Circuit Protection Selection

Providing UL508 type D combination ratings in accordance to current NEC installation requirements, the TeSys BV4 motor circuit protector allows for compact motor protection in conjunction with both the TeSys and Square D NEMA product families for motor control. The BV4 is a magnetic only, UL489 Listed circuit protector rated up to 100kA short-circuit protect with adjustable instantaneous trip points and can be installed directly to a panel or standard DIN rail.

Motor Circuit Protectors must be applied per a listed combination motor controller rating as required by NEC and UL 508A. See UL.com/SCCR for combination ratings or contact local support for a tested combination appendix.



Table 18.91: TeSys BV4 Motor Circuit Breaker Selection

Frame	MCP Ampacity (In)	Adjustable Instantaneous Trip (Ii)	Protection Level	
			Standard Fault Cat. No.	High Fault Cat. No.
BV4	2	12-28	BV4T002D	BV4T002J
	3.5	21-49	BV4T003D	BV4T003J
	7	42-98	BV4T007D	BV4T007J
	13	53-195	BV4T013D	BV4T013J
	25	110-360	BV4T025D	BV4T025J
	50	176-650	BV4T050D	BV4T050J
	80	320-1150	BV4T080D	BV4T080J
	115	600-1150	BV4T115D	BV4T115J

TeSys™ GV2 Accessories and Enclosures

Table 18.92: Mounting Accessories for GV2 + LC1 D09 to D38^[20]

	Mount GV Directly on Single DIN Rail	Mount on Single DIN Rail (Using Mounting Hardware)	Mount GV and LC1D Contactor on Independent DIN Rails	Mount on 2 DIN Rails (Using Mounting Hardware)
Electrical Interconnect	GV2AF3	GK2AF01	GV1G02	GV2AF4
Mounting Hardware	—		—	LAD311

Table 18.93: Mounting Accessories for GV2^[20]

Description	Application	Standard Pack ^[21]	Catalog Number
Adapter plate	For screw mounting of GV2M	10	GV2AF02
7.5 mm compensation plate	To allow mounting of GV2M and GV2P on a common bus bar	10	GV1F03

Table 18.94: Bus Bar Accessories for GV2

Description	Application	Pitch	Catalog Number
Incoming Terminal	Type E line spacer, for use with or without GV2G busbars	—	GV1G09
	Type E line spacer, not for use with or with GV2G busbars	—	GV2GH7
	Bottom Feed, for use with GV1L3 current limiter	—	GV1G05
3-Pole, 63 A Bus Bar	For feeding 2 GV2 starters	45	GV2G245
		54	GV2G254
		72	GV2G272
	For feeding 3 GV2 starters	45	GV2G345
		54	GV2G354
	For feeding 4 GV2 starters	45	GV2G445
		54	GV2G454
For feeding 5 GV2 starters	72	GV2G472	
Protective Cover	To cover unused bus bar outlets	—	GV1G10 ^[22]

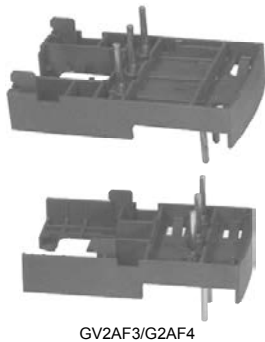

GV2AF3/GV2AF4

[20] Must order in multiples of 10.

[21] Orders must specify multiples of quantities listed.

[22] Must order in multiples of 5.

Table 18.95: GV2 Other Accessories

Description	Application	Standard Pack [23]	Catalog Number
Current limiter—GV2	Increases interrupt capacity when attached to GV2ME or GV2P	1	GV1L3
Through-the-door operating mechanism kits	NEMA 1, 12, Black with trip indication, for use with GV2P	1	GV2APN01
	NEMA 1, 12, Red/Yellow with trip indication, for use with GV2P	1	GV2APN02
	NEMA 3R, 4, 4X, Red/Yellow without trip indication, for use with GV2P	1	GV2APN04
Angle bracket	Operating mechanism support shaft for deep enclosures (≥ 250 mm), for use with GV2P	1	GVAPK11
Operating mechanism short shaft	One-piece short shaft for installing operating mechanisms in shallow enclosures, for use with GV2P, GV3P and TeSys U	1	GVAPA2
Laser tool	Laser tool for installing through-the-door kits	1	GVAPL01

Table 18.96: GV2 Enclosures

Description	Listing	Mounting	Enclosure Rating	Max. Side Mounting Aux. Contacts		Catalog Number
				Left Side	Right Side	
Enclosures for GV2ME with or without accessories	CSA Listed. Not UL Listed.	Surface mounting	NEMA 1, IP41	1	1	GV2MC01
			NEMA 12/4, IP55	1	1	GV2MC02
		Flush mounting	NEMA 1, IP41	1	1	GV2MP01
			NEMA 12/4, IP55	1	1	GV2MP02
		Flush mounting, front face reduced	NEMA 1, IP41	0	1	GV2MP03
			NEMA 12/4, IP55	0	1	GV2MP04

Table 18.97: GV2 Enclosures Accessories

Description	Type	Standard Pack [23]	Catalog Number	
Padlocking device for GV2M (when padlocked, starter is automatically in Off position)	—	1	GV2V01	
Mushroom head stop push button (40 mm, red) [24]	Spring return	1	GV2K011	
	Latching	Turn to Release	1	GV2K031
	Latching / Padlockable Turn to Release		1	GV2K04
Sealing kit	For enclosures GV2MC01 and GV2MP01	10	GV2E01	

[23] Orders must specify multiples of quantities listed.

[24] Supplied with IP55 sealing kit.

Voltage Trips

Table 18.98: Voltage Trips



GVAU116

Only one trip or fault signaling contact can be installed per GV2/GV3 device.				
Description	Characteristics	Voltage	Frequency	Cat. No. [25]
Voltage trips GV2 or GV3P	Undervoltage or Shunt trip (external mounting, 1 block right side only)	110–115 V	60 Hz	GVA●116
		220–240 V	60 Hz	GVA●226

Table 18.99: Voltage Trips—Technical Data (GV2AU, GV2AS)

Rated Voltage—660 Vac					
Model	Inrush	Sealed	Pick-Up Voltage	Drop-Out Voltage	Operating Time [26]
GVAU	12 VA / 8 W	3.5 VA / 1.1 W	0.8–1.1	0.35–0.7	10–15 ms
GVAS	14 VA / 10.5 W	5 VA / 1.6 W	0.7–1.1	0.2–0.75	10–15 ms

Table 18.100: Auxiliary Contact Blocks [27]



GVAE11

Description	Mounting Location	Max. No. of Blocks	Contact Type	Sold in lots of	Cat. No.
Instantaneous auxiliary contacts GV2 or GV3P	Front [28][29]	1	N.O. or N.C. [30]	1	GVAE1
			N.O. + N.C.	10	GVAE11
	Left Hand Side	2	N.O. + N.O.	1	GVAE20
			N.O. + N.C.	1	GVAN11
Fault signaling contact + instantaneous auxiliary contact GV2 or GV3P	Left Hand Side [31]	1	N.O. (fault) + N.O.	1	GVAD1010
			N.O. (fault) + N.C.	1	GVAD1001
			N.C. (fault) + N.O.	1	GVAD0110
			N.C. (fault) + N.C.	1	GVAD0101
Short circuit signaling contact GV2 or GV3P	Left Hand Side	1	SPDT	1	GVAM11

Table 18.101: GV3P Accessories

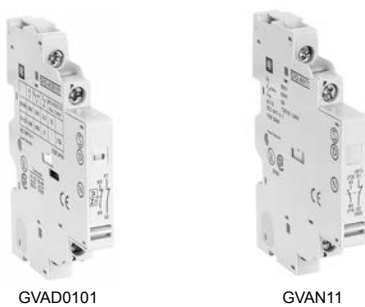

GVAD0101

GVAN11

Accessory	Application / Use With	Standard Pack	Cat. No.
Through-the-door operating mechanism kits	NEMA 1, 12, Black with trip indication, for use with GV3P	1	GV3APN01
	NEMA 1, 12, Red/Yellow, with trip indication, for use with GV3P	1	GV3APN02
	NEMA 3R, 4, 4X Red/Yellow without trip indication, for use with GV3P	1	GV3APN04
Angle bracket	Operating mechanism support shaft for deep enclosures (≥ 300 mm), for use with GV3P	1	GVAPK12
3-pole, 115 A busbar	For feeding 2 GV3P starters, 64 mm pitch	1	GV3G264
	For feeding 3 GV3P starters, 64 mm pitch	1	GV3G364
Incoming line spacer	Line spacer for GV3P when used in UL 508 Type E applications. One spacer required on line side.	1	GV3G66
IP 20 cover	IP20 protective cover for ring tongue versions of GV3P and 3-pole TeSys D Everlink contactors. Two covers required for line and load side.	1	LAD96570
Padlocking device	For use with up to 4 padlocks (not supplied), Ø 6 mm shank maximum	1	GV2V03
Operating mechanism short shaft	One-piece short shaft for installing operating mechanisms in shallow enclosures, for use with GV2P, GV3P and TeSys U	1	GVAPA2
Laser tool	Laser tool for installing through-the-door kits	1	GVAPL01
S-shaped busbar	For connecting GV3P starters and LC1D40A-65A contactors side by side without intrawiring	1	GV3S

[25] To order an undervoltage trip: replace the bullet (●) with a U (for example, GVAU025).

To order a shunt trip: replace the bullet (●) with an S (for example, GVAS025).

[26] From the loss of voltage at the trip terminals to the opening of the starter contacts.

[27] One trip or one fault signaling can be fitted per GV3.

[28] Cannot be used with GV2GH7 insulator.

[29] Mounting of a GVAE contact block or a GV2AK00 visible isolation block on GV2P.

[30] Choice of N.C. or N.O. contact operation, depending on which way the reversible block is mounted.

[31] The GVAD is always mounted next to the starter.

Common Accessories for BV4, GV4, GV5 and GV6

Common Accessories		BV4 Reference	GV4 Reference	GV5 Reference	GV6 Reference
Auxiliary contacts OF or SD					
Open/Closed Status		GV4AE11	GV4AE11	GV7AE11	GV7AE11
Trip Alarm		—	—	—	—
Open/Closed Status — Low Level		—	—	GV7AB11	GV7AB11
Fault signalization modules					
<p>For GV4PB, SDx module mounts externally on the right side, and provides pre-trip alarm and fault signalization</p> <ul style="list-style-type: none"> • SDT95% overload alarm: thermal image of the motor is greater than 95 % of the permissible temperature rise. • SDTxxs overload alarm: circuit breaker will trip in xx seconds with the same load. xx is adjustable between 10 to 40 seconds (default 20 seconds) on the circuit breaker itself through NFC or a computer with EcoStruxure Power Commission software and an interface module (TRV00911). • SDTAM overload alarm just before tripping: in the event of a phase unbalance, overload, or on a jam fault, this output is activated to open the contactor and avoid circuit breaker tripping. In that case, contact can be manually or automatically reseted after an adjustable cooling time from 1 to 15 minutes. If after a 400 ms delay the motor is not stopped, the circuit breaker will trip. • SDT overload trip indication: circuit breaker has tripped due to an overload fault. • SDJAM jam trip indication: circuit breaker has tripped due to a jam fault. • SDUNB phase unbalance trip indication: circuit breaker has tripped due to an unbalance fault. • SDLS long start trip indication: circuit breaker has tripped due to a long start fault. • SDGF ground-fault trip indication: circuit breaker has tripped due to a ground-fault. <p>For GV5PB & GV6PB, SDx module mounts internally, and includes a pre-trip contact (400 ms prior to trip) that can be use to open the contactor, as well as a contact that indicates overload trip of the circuit-breaker.</p>		—	GV4ADM1111	LV429424 (1)	LV429424 (1)
Instantaneous voltage release					
Undervoltage Release (Mn)	24 V 50/60 Hz	GV4AU027	GV4AU027	S29404	S29404
	24 Vdc	—	—	—	—
	48 V 50/60 Hz–48 Vdc	GV4AU057	GV4AU057	GV7AU055	GV7AU055
	110–130 V 50/60 Hz–125 Vdc	GV4AU137	GV4AU137	GV7AU107	GV7AU107
	208–240 V 50/60 Hz	GV4AU247	GV4AU247	GV7AU207	GV7AU207
	277 V 60 Hz	GV4AU286	GV4AU286	—	—
	380–415 V 50 Hz	GV4AU415	GV4AU415	GV7AU387	GV7AU387
	440–480 V 60 Hz	GV4AU486	GV4AU486	—	—
	525–600 V 60 Hz	—	—	S29409	S29409
	24 V 50/60 Hz	GV4AS027	GV4AS027	S29384	S29384
Shunt Trip (Mx)	24 Vdc	—	—	—	—
	48 V 50/60 Hz–48 Vdc	GV4AS057	GV4AS057	GV7AS055	GV7AS055
	110–130 V 50/60 Hz–125 Vdc	GV4AS137	GV4AS137	GV7AS107	GV7AS107
	208–240 V 50/60 Hz	GV4AS287	GV4AS287	GV7AS207	GV7AS207
	277 V 60 Hz	—	—	—	—
	380–415 V 50 Hz–440–480 V 60 Hz	GV4AS487	GV4AS487	GV7AS387	GV7AS387
	525–600 V 60 Hz	—	—	S29389	S29389
	—	—	—	—	—
Rotary handles					
Direct	With black handle on black font	GV4ADN01	GV4ADN01	GV5AP03	GV6AP03
	With red handle on yellow font	GV4ADN02	GV4ADN02	GV7AP04	LV432599
Front extended IP54	With black handle on black font	GV4APN01	GV4APN01	GV7AP01 (2)	LV432598 (2)
	With red handle on yellow font	GV4APN02	GV4APN02	GV7AP02 (2)	LV432600 (2)
Front extended IP65	With red handle on yellow font	GV4APN04	GV4APN04	—	—
Lateral	With black handle on black font	LV426935	LV426935	—	—
	With red handle on yellow font	LV426936	LV426936	—	—
Open door shaft operator		LV426937	LV426937	—	—
Laser alignment tool to aid in aligning hole on door with rotary mechanism		GVAPL01	GVAPL01	GVAPL01	GVAPL01

Additional BV4 and GV4 Accessories

Accessory	BV4 Reference	GV4 Reference
Cabling Accessories		
EverLink Connector (replacement)	LAD96565	LAD96565
Large Spacing Cover for EverLink Connector (replacement)	GV4G66	—
Crimp Lug Connector + Screws	GV4LUG	GV4LUG
Transparent Terminal Shield for Crimped Lug Connector	LAD96590	LAD96590
Interphase Barriers	LV426920	LV426920
One Time Torque Limiters, Green—9 N.m (set of 6)	LV426990	LV426990
One Time Torque Limiters, Yellow—5 N.m (set of 6)	LV426992	LV426992
Locking Accessories		
Removable Toggle Locking Device for 1 to 3 Padlocks	29370	—
Bag of 6 Leads + 6 Sealing Accessories	LV429375	—
Programming Tools		
Pocket Battery—Allows changes to settings on the GV4PB when not powered by the line voltage	—	LV434206
GV4PB cord for USB Maintenance Interface	—	TRV00917
EcoStruxure Power Commission app	—	Free download

Additional GV5 and GV6 Accessories

Accessory	GV5PB150.. Reference	GV5PB250.. Reference	GV6PB.. Reference	
Cabling Accessories				
Mechanical lug kit (set of 3)	14–10 AWG (2.5–6mm ²)—Al/Cu	AL150HD	—	
	14–2/0 AWG (2.5–70mm ²)—Cu	CU150HD1	—	
	4–4/0 AWG (25–95mm ²)—Al/Cu	—	AL175JD	
	3/0–350 kcmil AWG (95–185mm ²)—Al/Cu	—	AL250JD	
	1/0 AWG–300 kcmil (50–185mm ²)—Al/Cu	—	CU250JD1	
	2 AWG–500 kcmil (35–240mm ²)—Al	—	—	
	2 AWG–600 kcmil (35–300mm ²)—Cu	—	—	AL400L61K3
	2 AWG–600 kcmil (35–300mm ²)—Cu	—	—	CU400L61K3
	2/0 AWG–500 kcmil (70–240 mm ²)—Al/Cu	—	—	AL600LS52K3
	2/0 AWG–500 kcmil (70–240mm ²)—Cu	—	—	CU600LS52K3
	3/0 AWG–500 kcmil (95–240)—Al/Cu	—	—	AL600LF52K3
	3/0 AWG–500 kcmil (95–240)—Cu	—	—	CU600LF52K3
Terminal Nut Insert kit/Bus Bar Connections	1/4–20 Tap (set of 3)	S37444	S37445	
	M10 x 25 terminal screws and washers for one side (set of 4)	—	—	S36967
Terminal Shield	Short Terminal Shield	S37447	S37448	LTSS3P
	Medium Terminal Shield	—	—	LTSM3P
	Long Terminal Shield	—	—	LTSL3P
Phase Barriers	Phase Barriers (set of 6)	S29329	S29329	32570
Locking & Other Accessories				
Door Lock	Removable Door lock (lock off only)	S29370	S29370	S29370
	Fixed Door lock (on or off)	S29371	S29371	S32631
Toggle Extension	Fixed (set of 5)	S29313	S29313	S432553

Enclosed TeSys™ D Starters

TeSys D enclosed full-voltage starters are available in Type 1 and Type 12/3R enclosures. The enclosed TeSys D offer accepts standard TeSys D accessories and all Insta-Kits control units and control power transformer kits. For additional sizes, combinations and accessory options, see Catalog **8100CT1901**. Check with local sales office for availability.



LE1D093A62OB70

Table 18.102: Insta-Kits for Enclosed Full Voltage Non-Reversing Starters^[32]

Max. Horsepower Ratings						Auxiliary Contacts On Each Contactor		Current Rating of Contactor	Catalog Number ^[33]	
Single-Phase		Three-Phase				N.O.	N.C.		Type 1	Type 12/3R
120 V	240 V	208 V	230 V	460 V	575 V					
1/3	1	2	2	5	7.5	1	1	9	LE1D093A62O****	LE1D093A72O****
1/2	2	3	3	7.5	10	1	1	12	LE1D123A62O****	LE1D123A72O****
1	3	5	5	10	15	1	1	18	LE1D183A62O****	LE1D183A72O****
2	3	5	7.5	15	20	1	1	25	LE1D253A62O****	LE1D253A72O****
2	5	7.5	10	20	25	1	1	32	LE1D323A62O****	LE1D323A72O****
3	5	10	10	30	30	1	1	40	LE1D403A62O****	LE1D403A72O****
3	7.5	15	15	40	40	1	1	50	LE1D503A62O****	LE1D503A72O****
5	10	20	20	40	50	1	1	65	LE1D653A62O****	LE1D653A72O****

Table 18.103: Voltage Codes for Enclosed Starters

Primary Voltage	120	208	240
Code	G7	L7	U7

TeSys D dimensions: [page 18-55](#)

Insta-Kits Selection

With the use of Insta-Kits, only one operator scheme is allowed. For additional accessory kits and options, see Catalog **8100CT1901**. Check with local sales office for availability.

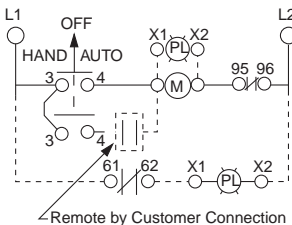
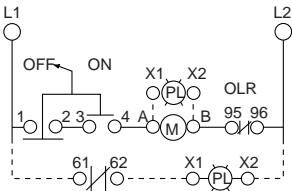
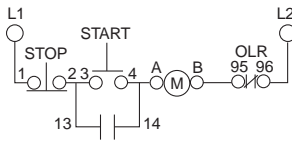

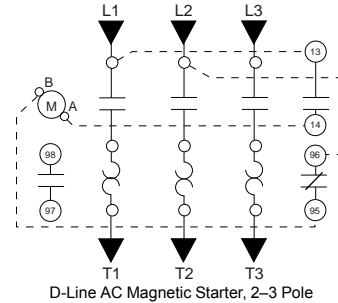

From top to bottom: Start/Stop, On - Off Selector Switch, HOA Selector Switch



^[32] See [Table 18.25 TeSys D Overload Relays—Ambient Compensated, Bimetallic, Direct Mounting](#), page 18-12 for field installable overload relays.

^[33] To obtain a single phase non-reversing starter, change prefix LE1 to LES. (e.g., LE1D093A62O**** becomes LESD093A62O****). Price remains unchanged.

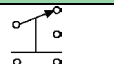
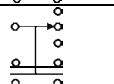
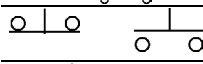
Table 18.104: Insta-Kit Accessories for Field Installation

Symbol	Description	Color	Nameplate	Suffix/Cat. No. [34]
				NEMA Type 1
One operator on cover				
	2 Position selector switch	Black	Off - On	LA9CA06DT
	3 Position selector switch	Black	Hand - Off - Auto	LA9CA06ET
	2 Push buttons	Green Red	Start Stop	LA9CA06GT
	3 Position selector switch, Pilot light (transformer type)	Black Red/Green	Hand - Off - Auto Power On	LA9CA06UT

TeSys™ LS1 Fuse Holders

- 45 mm wide (same dimensions as GV2ME)
- Mounts directly to LC1D09–D38 contactors (with use of GV2AF3 or GV2AF4)
- Meets application needs for fusible starter
- Uses GV2AE instantaneous contact blocks to open control circuits
- DIN rail mounted

Table 18.105: TeSys LS1 Fuse Holders

Description	Fuse Type	Dimensions		Catalog Number
		in.	mm	
Screw clamp terminals, 3-pole	CC, KTK-R	0.41 x 1.5	10.3 x 38	LS1D30



LS1D30

UL
E164862
CCN NLDX
SP
LR43364
Class 3211 04
CE

[34] Catalog numbers beginning with LA9 are only for starters with a "2" before the voltage code. When using a factory option that does not have a corresponding customer kit, the 10th digit of the starter must change from a "2" to a "1".

Altistart Drive and TeSys U Motor Starter

Table 18.106: Soft Start / Soft Stop Unit for 0.75 to 15 kW Motors (can be combined with the TeSys U starter)

Motor		Starter	
Motor Power, hp ^[1]		Nominal Current, A	Catalog Number
230 V	460 V		
3-phase supply voltage: 200 to 480 V 50/60 Hz			
1	2	6	ATSU01N206LT
1.5	3		
2	5	9	ATSU01N209LT
3	7.5		
5	10	22	ATSU01N222LT
7.5	15		
10	20		

Table 18.107: Accessories

Description	Used for Starter	Catalog Number
Power connector between ATSU 01N2●●LT and TeSys U	ATSU01N2●●T	VW3G4104

Table 18.108: TeSys U Starter and Soft Start Unit Combinations

Motor Power, hp		Soft Starter	TeSys U	
Voltage			Power Base	Control Unit ^[2]
200 V	460 V			
1	2	ATSU01N206LT	LUB 12	LUC●05BL
1.5	3	ATSU01N206LT		LUC●12BL
2	5	ATSU01N209LT		LUC●12BL
3	—	ATSU01N212LT		LUC●12BL
—	7.5	ATSU01N212LT		LUC●18BL
5	10	ATSU01N222LT		LUC●18BL
7.5	15	ATSU01N222LT	LUB 32	LUC●32BL
10	20	ATSU01N232LT		LUC●32BL



ATSU01●●



E164862
CCN NLDX



LR43364
Class 3211 04



[1] Standard motor power ratings, HP power ratings indicated according to standard UL 508.

[2] Depending on the configuration of the chosen TeSys U starter, replace the ● with **A** for standard, **B** for advanced, and **M** for multifunction. See Table 18.74 for a complete list of available control units. Control voltage must be 24 Vdc.

TeSys™ D—AC Coils

Table 18.109: For LC1D09–D38, LC1DT20–DT40 Contactors and CAD Relays

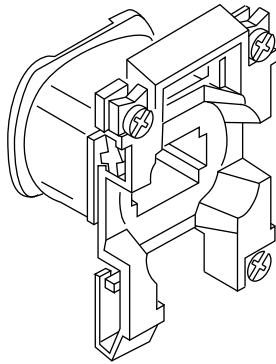

LX1D2

Rated Nominal Voltage	Catalog Number, 50/60 Hz
24	LXD1B7
120	LXD1G7
208	LXD1LE7
230/240	LXD1U7
277	LXD1W7
Specifications	50/60 Hz
Average consumption	
- Inrush (inductance 0.75)	70 VA
- Sealed (inductance 0.3)	7 VA
Operating range@ 60° C	80–110% of nominal @ 50 Hz, 85–110% of nominal @ 60 Hz

TeSys™ D—AC Coils

Table 18.110: For Old D2 Style LC1D40, D50, D65, D80, and D95; For TeSys D LC1D40A, D50A, D65A, DT60A, and DT80A; For TeSys D LC1D115 and D150

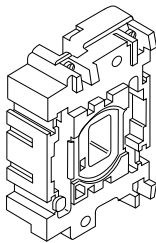

LX1D6

For TeSys D LC1D40A, D50A, D65A, DT60A, DT80A	
Rated Nominal Voltage, V	Catalog Number 50/60 Hz
For TeSys D LC1D40A, D50A, D65A, DT60A, DT80A	
24	LXD3B7
120	LXD3G7 ^[1]
208	LXD3LE7 ^[1]
240	LXD3U7
480	LXD3T7
Specification	50/60 Hz
Average consumption	
-inrush (inductance 0.3)	140 VA (Inductance: 0.9)
-sealed (inductance 0.3)	7.5 VA (Inductance: 0.9)
Operating range	
at $\theta \leq 55^\circ\text{C} / 131^\circ\text{F}$	80–115% of nominal voltage
For TeSys D LC1D115, D150	
24	LX1D8B7
120	LX1D8G7
208	LX1D8L7
240	LX1D8U7
277	LX1D8W7
480	LX1D8T7
Specification	50/60 Hz
Average consumption	
-inrush (inductance 0.8)	350 VA (Inductance: 0.9)
-sealed (inductance 0.3)	18 VA (Inductance: 0.9)
Operating range	
at $\theta \leq 55^\circ\text{C} / 131^\circ\text{F}$	80–115% of nominal voltage

Table 18.111: TeSys™ F—AC Coils (For LC1F115, F150, F185, F225, F265, F330, F400, F500, F630, F780, F800, and F1400–F2100)

Contactor	F115-F150	F185-F225	F265-F330	F400	F500	F630	F780 ^[2]	F800 ^[3]	F1400-F2100 ^[3]
Coil Part Number AC 50/60 Hz									
120 V	LX9FF127	LX9FG127	LX1FH1272	LX1FJ127	LX1FK127	LX1FL110	LX1FX110	LX4F8FW	LX1FK070 ^[4]
240 V	LX9FF220	LX9FG220	LX1FH2402	LX1FJ240	LX1FK240	LX1FL220	LX1FX220	LX4F8MW	LX1FK127
480 V	LX9FF500	LX9FG500	LX1FH5002	LX1FJ500	LX1FK500	LX1FL415	LX1FX415	—	LX1FK240
Coil Part Number DC									
24 V	LX4FF024	LX4FG024	LX4FH024	—	—	—	—	—	—

[1] 60 Hz only
 [2] LC1F780 contactors operate with 2 coils as a set. The LX1FX* part number includes both coils.
 [3] Also requires rectifier DR5TE4U for 110–240 V coils.
 [4] Order 2 coils and connect them in series.

TeSys™ F Contact Kits, Arc Chambers

Table 18.112: Replacement Contact Sets [5]

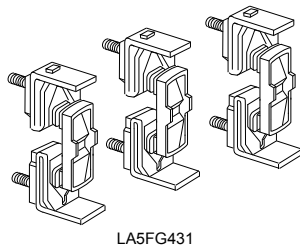

	For use on contactors	Number of Poles	Catalog Number
Three-pole	LC1F115, F150	3 poles	LA5FF431
	LC1F185, F225	3 poles	LA5FG431
	LC1F265	3 poles	LA5FH431
	LC1F330, F400	3 poles	LA5F400803
	LC1F500	3 poles	LA5F500803
	LC1F630	3 poles	LA5F630803
	LC1F780	1 pole	LA5F780801 [6]
	LC1F800	3 poles	LA5F800803

TeSys F contactors: page 18-14 and page 18-15
 TeSys F overload relay accessories: page 18-24
 TeSys F replacement coils and parts: page 18-40, and page 18-40
 TeSys F dimensions: page 18-45, page 18-54

TeSys™ AK5 Panel Busbar System

The AK5 pre-fabricated bus bar system provides a quick and easy method of mounting control devices. All components are finger safe, UL Listed, CSA approved and CE marked. Although the AK5 system can be screw mounted onto any type of support, it **must be mounted** on the AM1DL201 DIN rail when component mounting plates incorporating a tap-off are used. When using tap-offs, the nominal operating current of the bus bar (160 A @ 35°) must not be exceeded. Approvals include IEC 439, UL, CSA, DNV and LROS.

Table 18.113: 160 A, 3-Phase Busbar System

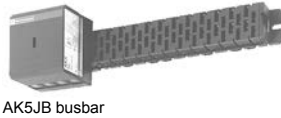

Maximum number of mounting plates					Length		Catalog Number	
Tap-off		Standard Width Plate		Extension Plate		in.		mm
1.42 in.	36 mm	2.13 in.	54 mm	2.80 in.	71 mm			
15		10		5		26.05	668	AK5JB146
24		16		8		38.69	992	AK5JB149

AK5JB busbar

Table 18.114: Mounting Plate Tap-off (plugs into busbar mounted on AM1DL201 DIN rail)

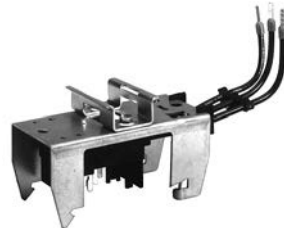

Width		Thermal Current Amperes	Application	Catalog Number
in.	mm			
2.13	54	25 A	GV2 with LUS or LUB 12 and 32 contactor	AK5PA231
2.13	54	25 A		AK5PA232

AK5PA231

Table 18.115: Bus Tap-off (plugs into busbar for wiring to a separately mounted device)

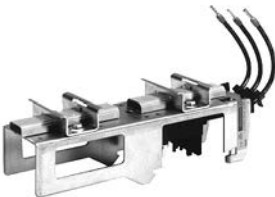

Width		Thermal Current (A)	Length of Leads		Catalog Number
in.	mm		in.	mm	
1.42	36	32 A	9.84	250	AK5PC33
1.42	36	32 A	39.37	1000	AK5PC33L

AK5PA232S

Table 18.116: Mounting Rail (must be used for mounting plates with tap-offs)



Description	Depth	Length	Catalog Number
	mm	mm	
75 mm Omega Rail	15	2000	AM1DL201

AK5PC33



AM1DL201



File E161251
CCN NMTR



File LR 89150
Class 6228-01

[5] Supplied per pole are: 2 fixed contacts, 1 moving contact, 2 deflectors, 1 backplate, mounting screws and washers.

[6] Two identical components per pole are supplied.

TeSys™ island Load Management System Module Dimensions

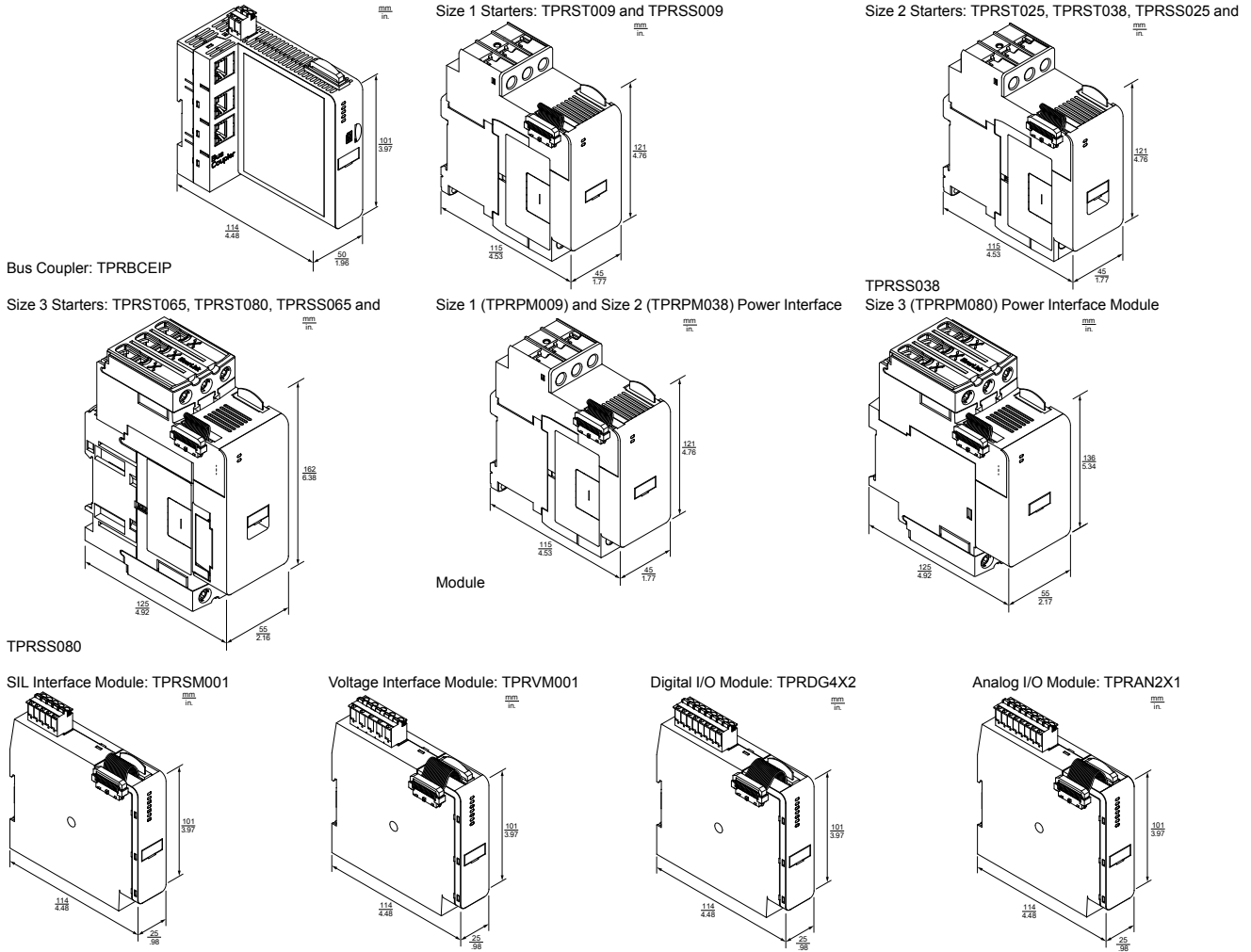

TeSys™ D Contactors, AC and DC Coil

Table 18.117: TeSys D 9 to 38 A Contactors, AC and DC Coils

LC1D09 to D18		LC1D25 to D38 (3-pole) and LC1DT20 to DT40 (4-pole)				
TeSys D contactors: LC1D		D09 to D18 in. (mm)	D25 to D38 in. (mm)	D098, D128, DT20, DT25 in. (mm)	DT32, DT40 in. (mm)	D188, D258 in. (mm)
b	AC coil, without add-on accessories	3.03 (77)	3.36 (85)	3.34 (85)	3.58 (91)	4.13 (105)
	DC coil	3.03 (77)	3.36 (85)	3.34 (85)	3.58 (91)	4.13 (105)
b1	AC coil, with LAD4BB	3.70 (94)	3.85 (98)	3.85 (98)	—	—
	AC coil, with LA4D*2	4.33 (110) [1]	4.48 (114) [1]	4.48 (114)	—	—
	AC coil, with LA4DF, DT	4.68 (119) [1]	4.84 (123) [1]	5.02 (129)	—	—
	AC coil, with LA4DR, DW, DL	4.96 (126) [1]	5.11 (130) [1]	7.48 (190)	—	—
c	AC coil, without cover or add-on blocks	3.30 (84)	3.54 (90)	3.54 (90)	3.85 (98)	3.85 (98)
	AC coil, with cover, without add-on blocks	3.38 (86)	3.62 (92)	3.62 (92)	3.93 (100)	3.93 (100)
	DC coil, without cover or add-on blocks	3.66 (93)	3.89 (99)	—	—	—
	DC coil, with cover, without add-on blocks	3.76 (95)	3.97 (101)	3.90 (99)	4.21 (107)	4.21 (107)
c1	AC coil, with LADN or C (two or four contacts)	4.60 (117)	4.84 (123)	4.84 (123)	5.15 (131)	5.15 (131)
	DC coil, with LADN or C (two or four contacts)	4.96 (126)	5.19 (132)	4.84 (123)	5.15 (131)	5.15 (131)
c2	AC coil, with LAD6K10	5.07 (129)	5.31 (135)	5.31 (135)	5.62 (143)	5.62 (143)

[1] Including LAD4BB.

Table 18.117 TeSys D 9 to 38 A Contactors, AC and DC Coils (cont'd.)

LC1D09 to D18		LC1D25 to D38 (3-pole) and LC1DT20 to DT40 (4-pole)				
						
TeSys D contactors: LC1D		D09 to D18 in. (mm)	D25 to D38 in. (mm)	D098, D128, DT20, DT25 in. (mm)	DT32, DT40 in. (mm)	D188, D258 in. (mm)
c3	DC coil, with LAD6K10	5.43 (138)	5.66 (144)	5.31 (135)	5.62 (143)	5.62 (143)
	AC coil, with LADT, R, S	5.39 (137)	5.62 (143)	5.62 (143)	5.94 (151)	5.94 (151)
	AC coil, with LADT, R, S and sealing cover	5.55 (141)	5.78 (147)	5.78 (147)	6.10 (155)	6.10 (155)
	DC coil with LADT, R, S	5.76 (146)	5.98 (152)	5.62 (143)	5.94 (151)	5.94 (151)
	DC coil with LADT, R, S and sealing cover	5.90 (150)	6.14 (156)	5.78 (147)	6.10 (155)	6.10 (155)

Table 18.118: TeSys D 40 A to 65 A, AC and DC coil

LC1 D40A–D65A (3P), LC1 DT60A–DT80A (4P) AC OR DC		LC1		D40A–D65A in. (mm)	DT60A–DT80A in. (mm)
	a	with LA4 D●2	2.17 (55)	2.76 (70)	—
	b1	with LA4 DB3 or LAD 4BB3	5.35 (136)	—	—
		with LA4 DF, DT	6.18 (157)	—	—
		with LA4 DM, DW, DL	6.54 (166)	—	—
	c	without cover or add-on blocks	4.65 (118)	4.65 (118)	—
		with cover, without add-on blocks	4.72 (120)	4.72 (120)	—
	c1	with LADN (1 contact)	—	—	—
		with LADN or C (2 or 4 contacts)	5.91 (150)	5.91 (150)	—
	c2	with LAD 6K10 or LA6 DK	6.42 (163)	6.42 (163)	—
		with LADT, R, S	6.73 (171)	6.73 (171)	—
c3	with LADT, R, S and sealing cover	6.89 (175)	6.89 (175)	—	

Table 18.119: TeSys D80 and D95 AC Coil

LC1D80 and D95 (3P), LP1 D80004 and D80008 (4P)		LC1				
		D80 in. (mm)	D95 in. (mm)	D80004 in. (mm)	D80008 in. (mm)	
	a	3.35 (85)	3.35 (85)	3.78 (96)	3.78 (96)	
	b1	with LA4 D●2	5.31 (135)	5.31 (135)	5.31 (135)	5.31 (135)
		with LA4 DB3 or LAD 4BB3	5.31 (135)	—	—	—
		with LA4 DF, DT	5.59 (142)	5.59 (142)	5.59 (142)	5.59 (142)
		with LA4 DM, DW, DL	5.90 (150)	5.90 (150)	5.90 (150)	5.90 (150)
	c	without cover or add-on blocks	4.92 (125)	4.92 (125)	4.92 (125)	5.51 (140)
		with cover, without add-on blocks	5.12 (130)	5.12 (130)	—	—
	c1	with LADN (1 contact)	5.90 (150)	5.90 (150)	5.90 (150)	5.90 (150)
		with LADN or C (2 or 4 contacts)	6.22 (158)	6.22 (158)	6.22 (158)	6.22 (158)
	c2	with LAD 6K10 or LA6 DK	6.69 (170)	6.69 (170)	6.69 (170)	6.69 (170)
with LADT, R, S		7 (178)	7 (178)	7 (178)	7 (178)	
c3	with LADT, R, S and sealing cover	7.16 (182)	7.16 (182)	7.16 (182)	7.16 (182)	

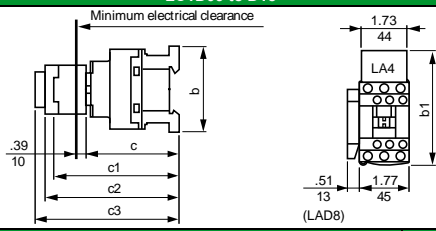
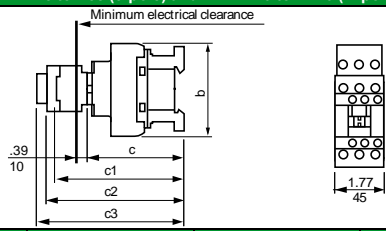
TeSys™ D Contactors, DC Coil

Table 18.120: DC Coil

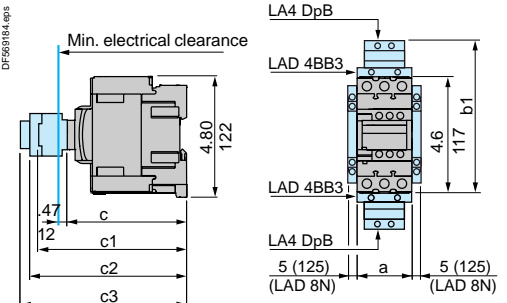
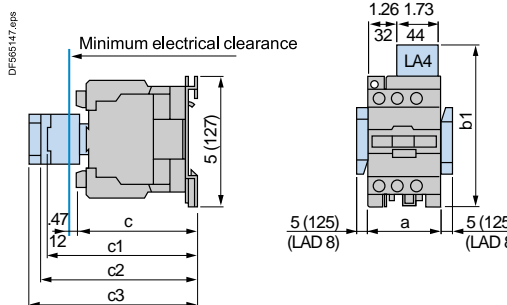
LC1D80, D95 (3P), LP1D80004, D80008 (4P)	LC1	D80 and D95	D80004	D80008	
		in. (mm)	in. (mm)	in. (mm)	
	a	3.35 (85)	3.78 (96)	3.78 (96)	
	b1	with LAD 4BB3	—	—	—
		with LA4 DF, DT	—	—	—
	c	without cover or add-on blocks	7.13 (181)	7.13 (181)	7.72 (196)
		with cover, without add-on blocks	7.32 (186)	—	—
	c1	with LAD N (1 contact)	8.03 (204)	8.03 (204)	8.03 (204)
		with LAD N or C (2 or 4 contacts)	8.27 (210)	8.27 (210)	8.27 (210)
	c2	with LA6 DK10	8.70 (221)	8.70 (221)	8.70 (221)
	c3	with LAD T, R, S	9.01 (229)	9.01 (229)	9.01 (229)
		with LAD T, R, S and sealing cover	9.17 (233)	9.17 (233)	9.17 (233)

LC1D115, D150 (3P), LC1D115004 (4P), AC and DC Coils Panel mounted with 1/4" screws	LC1	D115, D150	D115004	D1150046	
		in. (mm)	in. (mm)	in. (mm)	
	a	4.72 (120)	5.91 (150)	6.10 (155)	
	b1	with LA4DA2	6.85 (174)	6.85 (174)	6.85 (174)
		with LA4DF, DT	7.28 (185)	7.28 (185)	7.28 (185)
		with LA4DM, DL	7.40 (188)	7.40 (188)	7.40 (188)
	c	with LA4DW	5.20 (132)	5.20 (132)	4.53 (115)
		without cover or add-on blocks	5.35 (136)	—	—
	c1	with cover, without add-on blocks	5.35 (136)	—	—
	c2	with LAD N or C (2 or 4 contacts)	5.91 (150)	5.91 (150)	5.91 (150)
	c3	with LAD T, R, S	6.10 (155)	6.10 (155)	6.10 (155)
		with LAD T, R, S and sealing cover	6.61 (168)	6.61 (168)	6.61 (168)

TeSys™ F Contactors, Dimensions

All dimensions shown in mm.
To convert to inches, divide by 25.4.

LC1F115 to F330

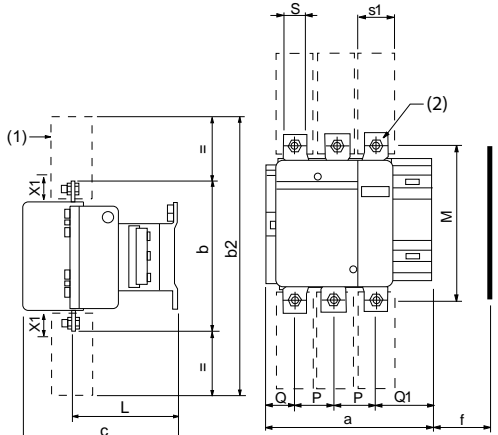

(1) Protective cover
Type LA9F70•

(2) Optimal terminal shroud

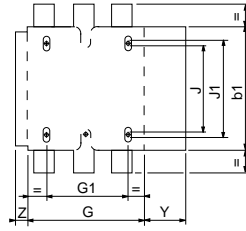

Table 18.121: LC1F115–F330 Dimensions

LC1	F115		F150		F185		F225		F265		F330	
	3-Pole	4-Pole	3-Pole	4-Pole	3-Pole	4-Pole	3-Pole	4-Pole	3-Pole	4-Pole	3-Pole	4-Pole
a	163.5	200.5	163.5	200.5	168.5	208.5	168.5	208.5	201.5	243.5	213	261
b	162	162	170	170	174	174	197	197	203	203	206	206
b1	137	137	137	137	137	137	137	137	145	145	145	145
b2	265	265	301	301	305	305	364	364	370	370	375	375
c	165 [2]	165 [2]	165 [2]	165 [2]	176	176	181	181	207	207	219	219
f	131	131	131	131	130	130	130	130	147	147	147	147
G	106	143	106	143	111	151	111	151	142	190	154.5	202.5
G1	80	80	80	80	80	80	80	80	96	96	96	96
J	106	106	106	106	106	106	106	106	106	106	106	106
J1	120	120	120	120	120	120	120	120	120	120	120	120
L	107	107	107	107	113.5	113.5	113.5	113.5	141	141	145	145
M	147	147	150	150	154	154	172	172	178	178	181	181
P	37	37	40	40	40	40	48	48	48	48	48	48
Q	29.5	29.5	26.5	26	29	29	21	17	39	34	43	43
Q1	60	60	57.5	55.5	59.5	59.5	51.5	47.5	66.5	66.5	74	74
S	15	15	20	20	20	20	25	25	25	25	25	25
S1	27	27	34	34	34	34	44.5	44.5	38	38	44.5	44.5
Y	44	44	44	44	44	44	44	44	38	38	38	38
Z	13.5	13.5	13.5	13.5	13.5	13.5	13.5	13.5	21.5	21.5	20.5	20.5

f = minimum distance required for coil removal.

Table 18.122: LC1F115–F330 Voltage

	200 to 500 V	600 to 1000 V
LC1F115, F150	10	15
LC1F185	10	15
LC1F225, F265	10	15
LC1F330	10	15

X1: Minimum clearance according to the operational voltage and the breaking capacity.

LC1F400 to F500

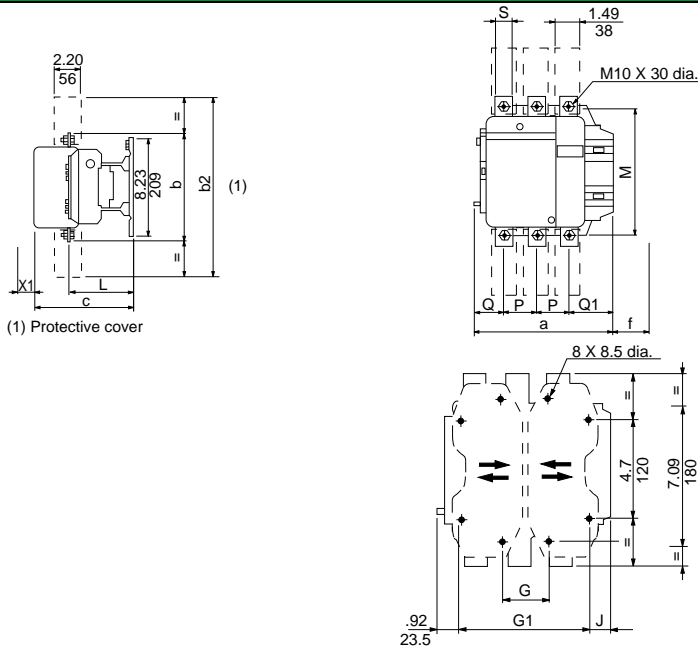

(1) Protective cover

Table 18.123: LC1F400–F500 Dimensions

LC1	F400			F500		
	2-Pole	3-Pole	4-Pole	2-Pole	3-Pole	4-Pole
a	213	213	261	233	233	288
b	206	206	206	238	238	238
b2	375	375	375	400	400	400
c	213	213	213	226	226	226
f	119	119	119	141	141	141
G [3]	80	80	80	80	80	140
G min.	66	66	66	66	66	66
G max.	102	102	150	120	120	175
G1 [3]	170	170	170	170	170	230
G1 min.	156	156	156	156	156	156
G1 max.	192	192	240	210	210	265
J	19.5	19.5	67.5	39.5	39.5	34.5
L	145	145	145	146	146	146
M	181	181	181	208	208	208
P	48	48	48	55	55	55
Q	69	43	43	76	46	46
Q1	96	74	74	102	77	77
S	25	25	25	30	30	30

f = Minimum distance required for coil removal.

Table 18.124: LC1F400–F500 Voltage

	200 to 500 V	600 to 1000 V
LC1F400	15	20
LC1F500	15	20

X1: Minimum clearance according to the operational voltage and the breaking capacity.

[2] +6 mm with time delay block (for F115 and F150).
[3] Supplied.

Table 18.125: LC1F Dimensions

LC1F630 and LC1F800

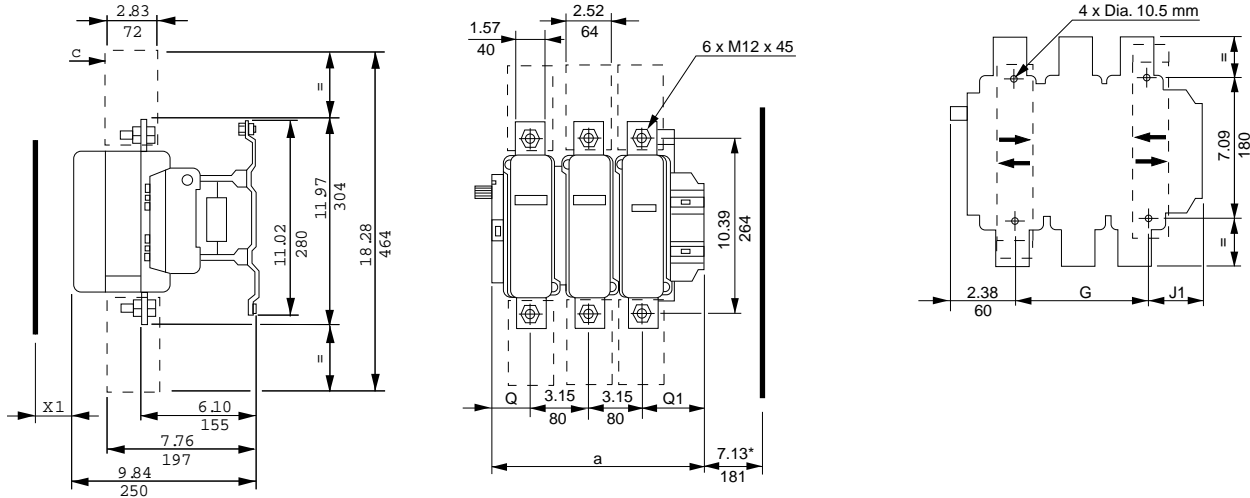

X1: Minimum clearance according to the operational voltage and the breaking capacity.

	LC1F630	a	G supplied	G min.	G max.	J1	Q	Q1							
* = minimum distance required for coil removal.	2 P	12.17	309	7.09	180	3.94	100	7.68	195	2.70	68.5	4.02	102	5.00	127
♦ Protective terminal cover.	3 P	12.17	309	7.09	180	3.94	100	7.68	195	2.70	68.5	2.36	60	3.50	89
	4 P	15.31	389	9.45	240	5.91	150	10.83	275	2.70	68.5	2.36	60	3.50	89

Voltage (V)	200–500 V	690–1000 V	200–690 V	1000 V
F630	20	30	—	—
F800	—	—	10	20

LC1F780, F7804

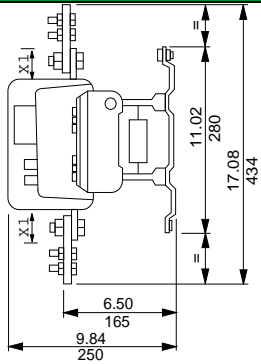

X1: Minimum clearance according to the operational voltage and the breaking capacity.

Voltage (V)	200–500 V	690–1000 V
X1 in mm	30	35

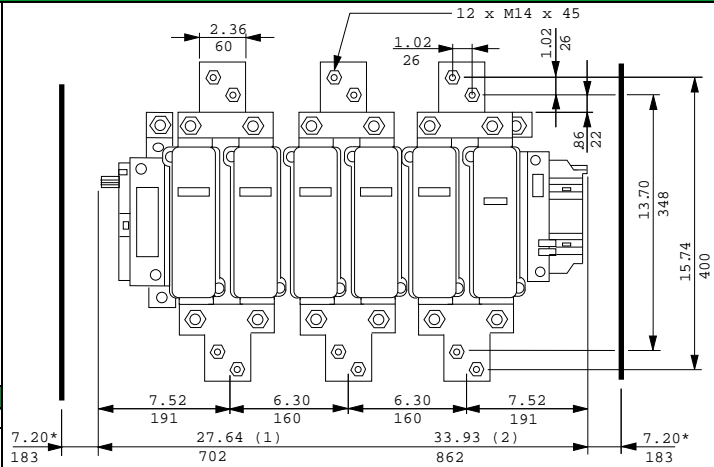

1) Overall length (3 poles).
2) Overall length (4 poles).
* Minimum distance required for coil removal.

LC1F780 mounting

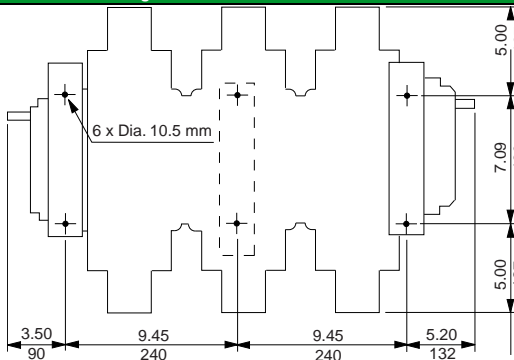

LC1F7804 mounting

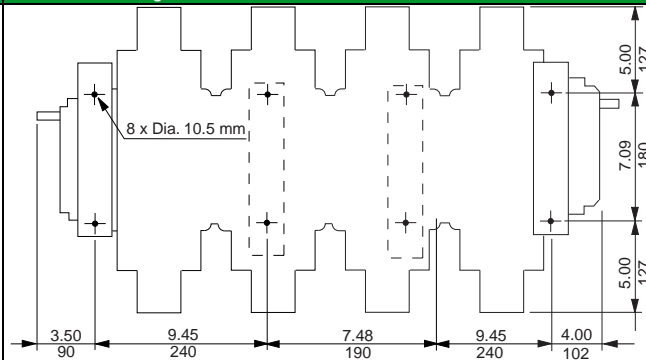

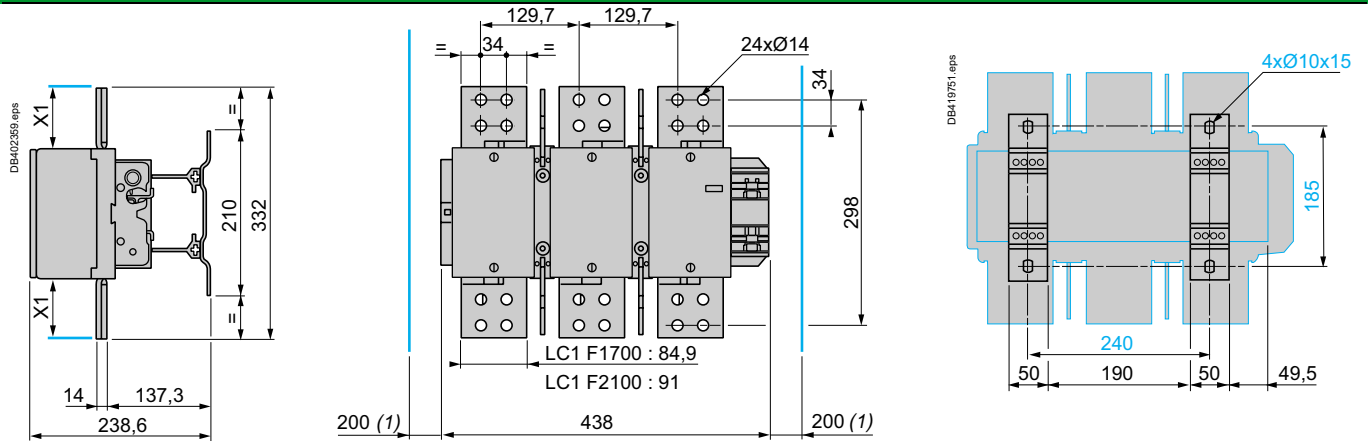

X1: Minimum clearance according to the operational voltage and the breaking capacity.
 1) Minimum distance required for coil removal.

Voltage (V)	200–500 V	690–1000 V
X1 in mm	90	100

TeSys™ D Reversing Contactor Dimensions

Table 18.126: Reversing Contactor Dimensions

LC2D09–D38
2 x LC1D09 to D38

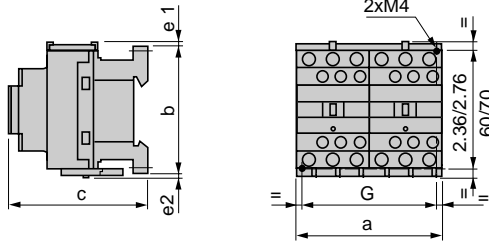

LC2 or 2 x LC1	a	b	c [4]	e1	e2	G
	in. (mm)	in. (mm)	in. (mm)	in. (mm)	in. (mm)	in. (mm)
D09 to D18 (AC Coil)	3.54 (90)	3.03 (77)	3.38 (86)	0.16 (4)	0.06 (1.5)	3.14 (80)
D093 to D123 (AC Coil)	3.54 (90)	3.9 (99)	3.38 (86)	—	—	3.14 (80)
D09 to D18 (DC Coil)	3.54 (90)	3.03 (77)	3.74 (95)	0.16 (4)	0.06 (1.5)	3.14 (80)
D093 to D123 (DC Coil)	3.54 (90)	3.9 (99)	3.74 (95)	—	—	3.14 (80)
D25 to D38 (AC Coil)	3.54 (90)	3.34 (85)	3.62 (92)	0.35 (9)	0.20 (5)	3.14 (80)
D183 to D383 (AC Coil)	3.54 (90)	3.9 (99)	3.62 (92)	—	—	3.14 (80)
D25 and D32 (DC Coil)	3.54 (90)	3.34 (85)	3.98 (101)	0.35 (9)	0.20 (5)	3.14 (80)
D183 to D383 (DC Coil)	3.54 (90)	3.9 (99)	3.98 (101)	—	—	3.14 (80)

e1 and e2: includes cabling

LC2DT20 to DT40
2 x LC1 DT20 to DT40

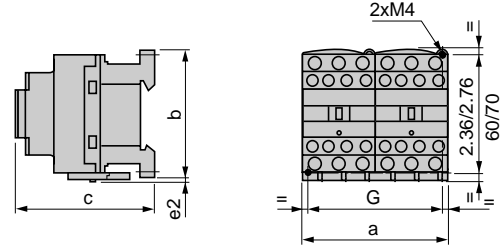

LC2 or 2 x LC1	a	b	c	G
	in. (mm)	in. (mm)	in. (mm)	in. (mm)
DT20 and DT25 (AC Coil)	3.54 (90)	3.34 (85)	3.62 (92)	3.14 (80)
DT32 and DT40 (AC Coil)	3.54 (90)	3.58 (91)	3.9 (99)	3.14 (80)
DT20 and DT25 (DC Coil)	3.54 (90)	3.34 (85)	4 (102)	3.14 (80)
DT32 and DT40 (DC Coil)	3.54 (90)	3.58 (91)	4.29 (109)	3.14 (80)

c, e: includes cabling

LC2D40A to D65A
2 x LC1D40A to D65A

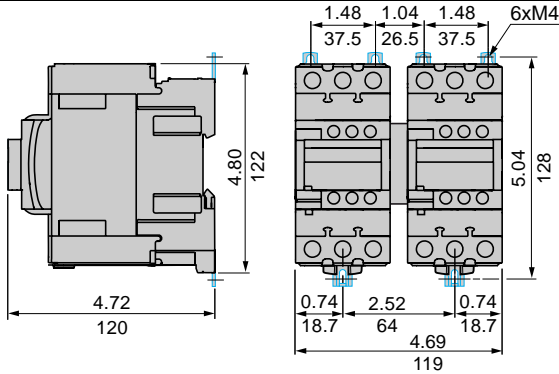

LC2D80 and D95
2 x LC1D80 and D95 (AC Coil)

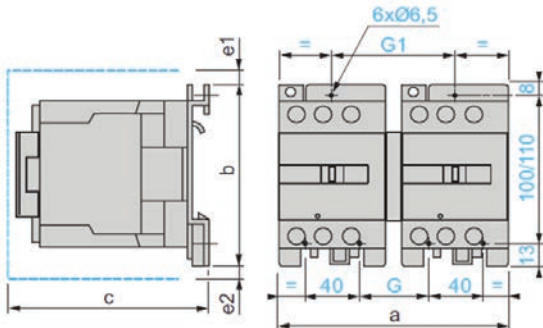

LC2 or 2 x LC1	a	b	c	e1	e2	G	G1
	in. (mm)	in. (mm)	in. (mm)	in. (mm)	in. (mm)	in. (mm)	in. (mm)
D80 and D95	7.17 (182)	5 (127)	6.22 (158)	0.51 (13)	—	2.24 (57)	3.78 (96)
D80004	8.15 (207)	5 (127)	6.22 (158)	—	0.79 (20)	2.8 (71)	4.37 (111)

c, e1, and e2: includes cabling

2 x LC1D80 and D95 (DC Coil)

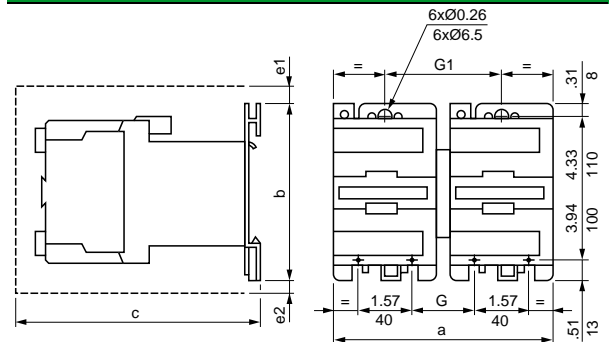

2 x LC1	a	b	c	e1	e2	G	G1
	in. (mm)	in. (mm)	in. (mm)	in. (mm)	in. (mm)	in. (mm)	in. (mm)
D80 and D95	8.15 (207)	5.0 (127)	8.46 (215)	0.51 (13)	0.79 (20)	3.78 (96)	4.37 (111)

c, e1 and e2: includes cabling.

[4] With safety cover, without add-on block.

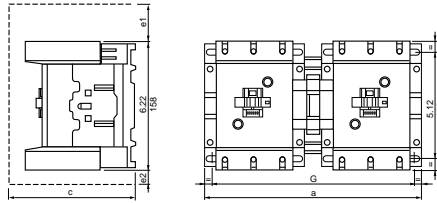

LC2 or 2 x LC1	a	c	e1	e2	G
	in. (mm)	in. (mm)	in. (mm)	in. (mm)	in. (mm)
D115, D150	10.47 (266)	5.83 (148)	2.2 (56)	0.71 (18)	9.53/10.08 (242/256)
D115004	13.15 (334)	5.83 (148)	—	2.36 (60)	12.2/12.76 (310/324)

c, e1 and e2 includes cabling

NOTE: For dimensions of TeSys F reversing contactors, please refer to catalog [MKTED210011EN](#).

TeSys™ D Open Starter Dimensions

Table 18.127: TeSys D Thermal Overload Relay Dimensions, in. (mm)

LRD01-35
Direct mounting beneath contactors with screw clamp connections

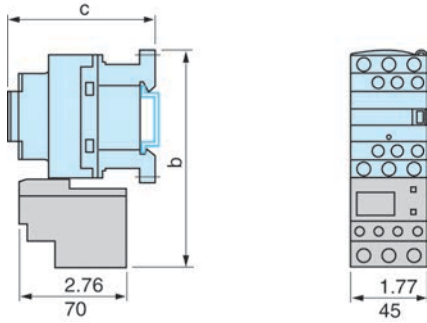

LC1•	D09–D18	D25–D38
b	4.84 (123)	5.39 (137)
c	See page 18-42	

LRD04L-32L
Direct mounting beneath contactors with screw clamp connections

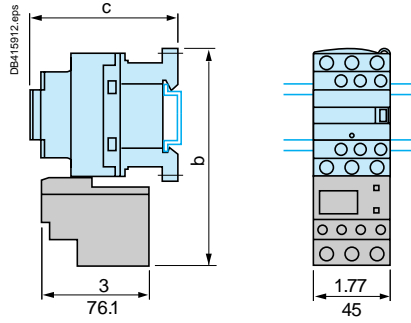

LC1•	D09–D18	D25–D38
b	4.84 (123)	5.39 (137)
c	See page 18-42	

LR9D01, 02, 08, and 32

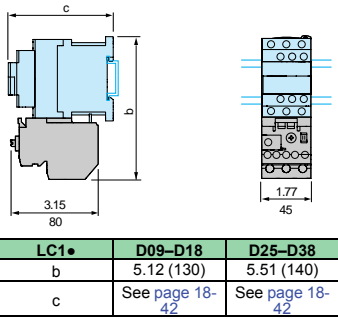

LC1•	D09–D18	D25–D38
b	5.12 (130)	5.51 (140)
c	See page 18-42	See page 18-42

LRD313–365
Direct mounting beneath LC1D40A to D65A with screw clamp connectors or EverLink connectors

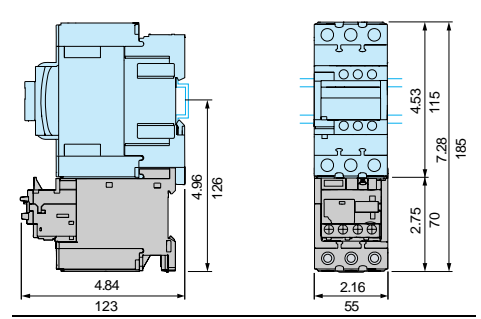

LRD33•••
Direct mounting beneath contactors LC1D80 to D95

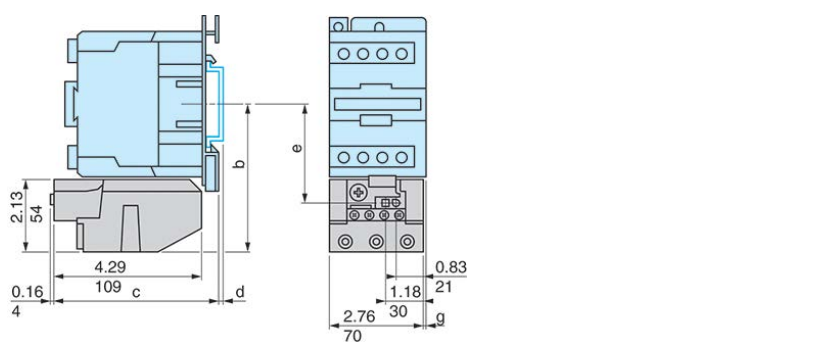

AM1•	DL201		DL200		
d	0.28 (7)		0.67 (17)		
	b	c	e	g (3P)	g (4P)
AC Control Circuit					
LC1D80	4.55 (115.5)	4.88 (124)	3.03 (76.9)	0.37 (9.5)	0.87 (22)
LC1D95	4.55 (115.5)	4.88 (124)	3.03 (76.9)	0.37 (9.5)	—
DC Control Circuit					
LP1D80	4.55 (115.5)	7.06 (179.4)	3.03 (76.9)	0.37 (9.5)	0.87 (22)

www.se.com/us

LRD4••••[5]
Direct mounting beneath contactors LC1D115 and D150

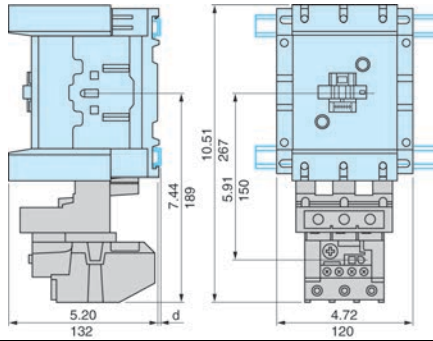

AM1	DL200 and DR200	DE200 and ED•••
d	0.10 (2.5)	0.41 (10.5)

LR9D5••• and LR9D6•[5]
Direct mounting beneath contactors LC1D115 and D150

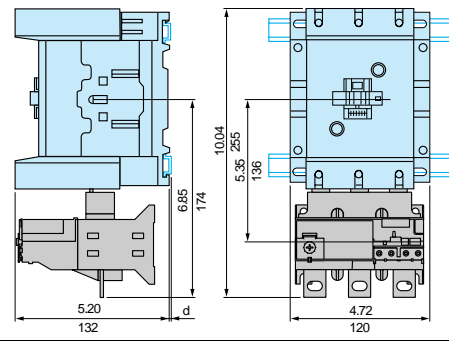

AM1	DP200 and DR200	DE200 and ED•••
d	0.10 (2.5)	0.41 (10.5)

[5] For additional specifications and selection information, see catalog [MKTED210011EN](#)

TeSys™ D Thermal Overload Relay Dimensions

LRD01-35
Independent mounting on 1.97 in. (50 mm) centers or on rail AM1DP200 or DE200

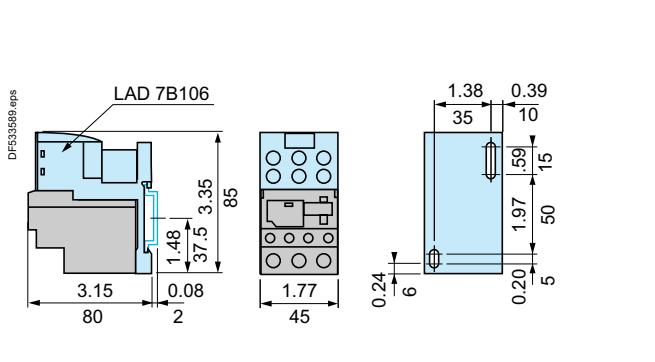

Independent mounting on 4.33 in. (110 mm) centers

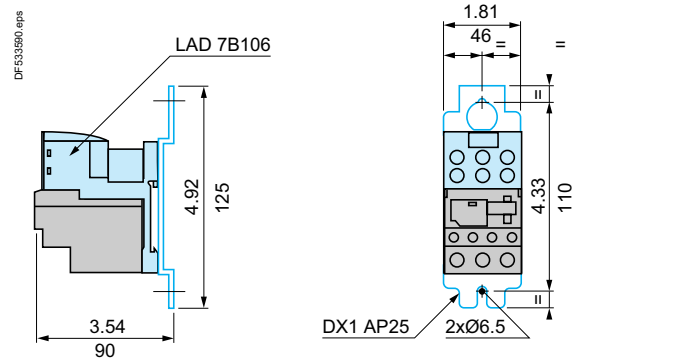

LRD04L-32L
Independent mounting on 1.97 in. (50 mm) centers or on rail AM1DP200 or DE200

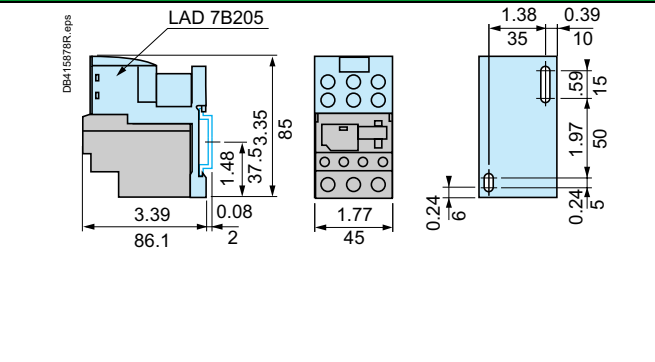

Independent mounting on 4.33 in. (110 mm) centers

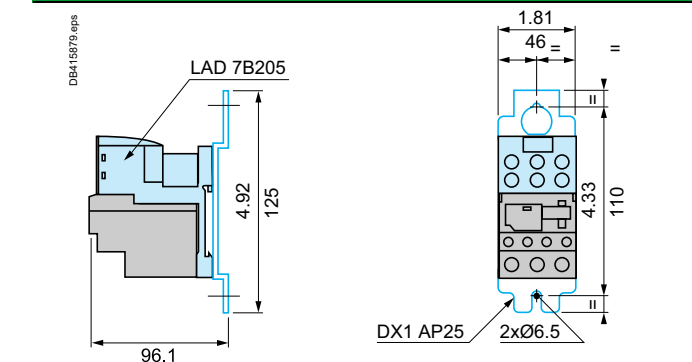

AM1	DP200	DE200
d	0.08 (2)	0.37 (9.5)

LRD313-365
Mounting on rail AM1D•200 or ED200

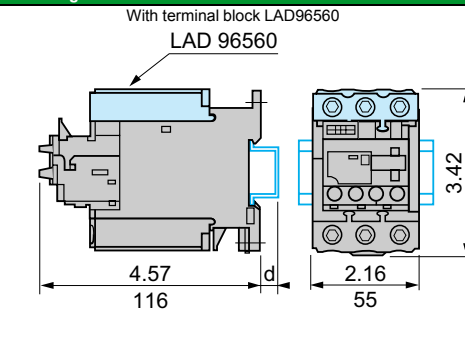

Panel mounting

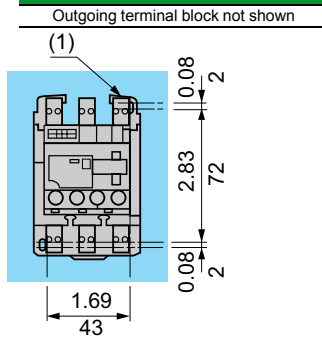

Mounted on plate AM1P

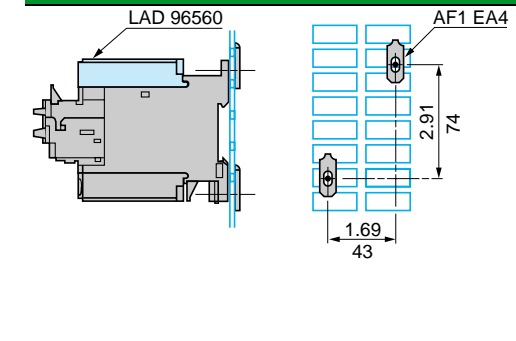

AM1	DP200	DE200	ED200
d	0.08 (2)	0.37 (9.5)	0.37 (9.5)

(1) 2 elongated holes Ø4.2 x 6.

LRD01-35 and LRD313-365
Remote tripping or electrical reset

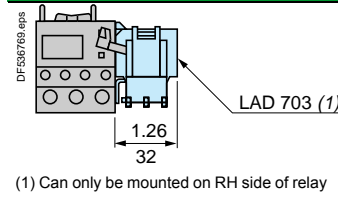

(1) Can only be mounted on RH side of relay

www.se.com/us

LR9D01-D32

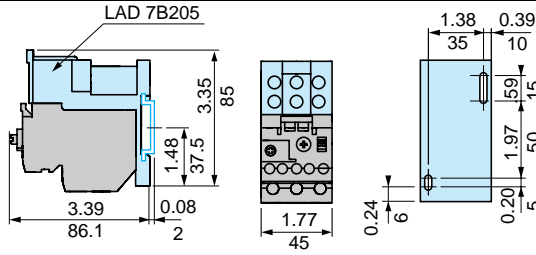

LR9D110S

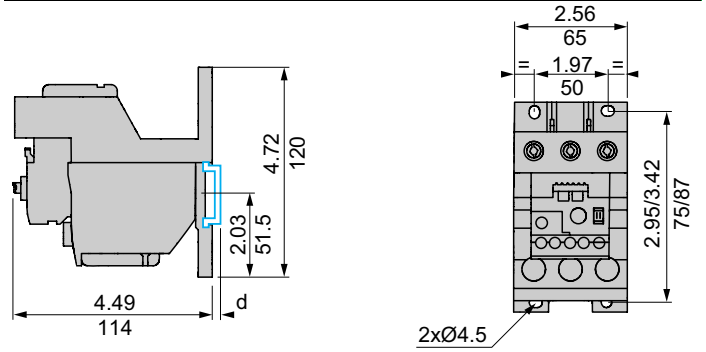

LRD3... and LR2D35...
Independent mounting on 1.97 in. (50 mm) centers or on rail AM1DP200 or DE200

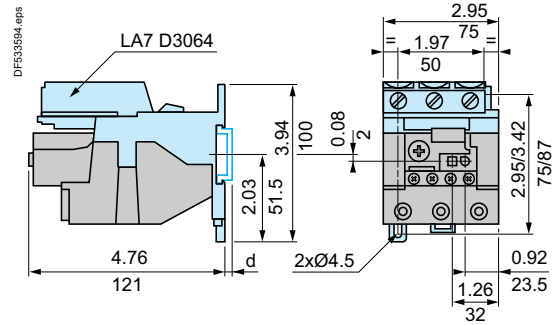

LRD3... , LR2D35... , and LR9D5
Remote tripping or electrical reset

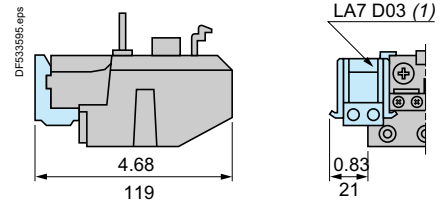

AM1	DP200	DE200
d	0.08 (2)	0.37 (9.5)

(1) Can be mounted on RH or LH side of relay LRD3... , LR2D35... , or LR9D

LRD3... Adapter for door-mounted operator

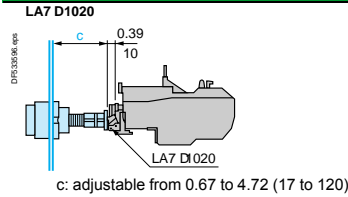

LRD, LRD313-365, LRD04-32L, LR9D5, and LR9D6
"Reset" by flexible cable

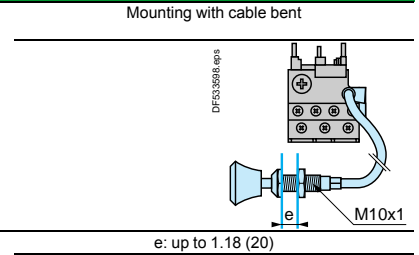
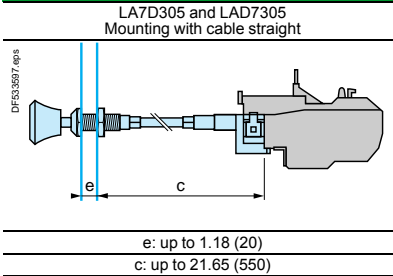

TeSys™ D Combination Starter Dimensions

Table 18.129: Non-Combination Starter Dimensions [6]

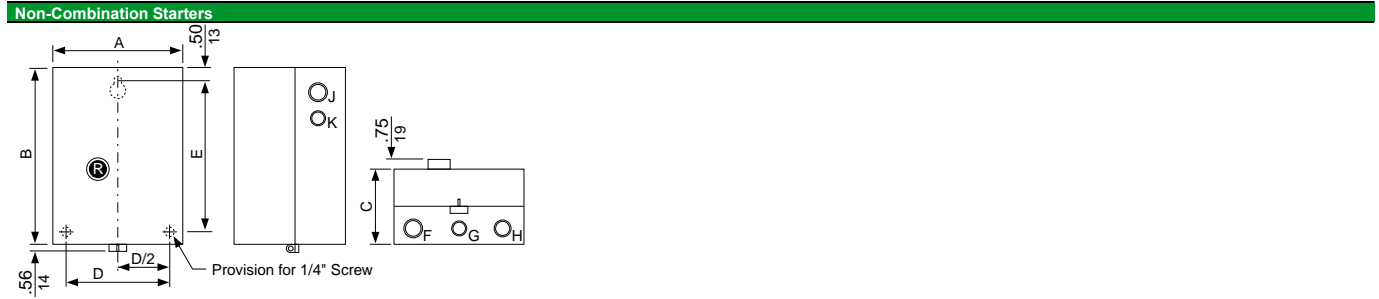

		Type 1										Type 12/3R	
Non-Reversing	Reversing	A	B	C	D	E	F	G	H	J	K	D	E
D09-32	—	6.77	10.04	6.25	5.38	9.00	1-1.25	0.5-0.75	—	1-0.25	0.5-0.75	5.38	11.37
D40-65	D09-32	8.66	10.83	7.21	7.25	9.75	1.25-1.5	0.5-0.75	1-1.25	1-0.25	0.5-0.75	5.38	12.15

[6] All dimensions in inches.

TeSys™ K Contactor Dimensions

Table 18.130: TeSys K Contactor Dimensions

<p>LR2K Direct mounting under the contactor</p>	<p>Separate mounting with LA7-K0064 terminal block on 35 mm rail (AM1DP200 or AM1DE200)</p>
<p>Three-phase</p>	<p>Wiring Scheme</p>
<p>LC1, LP1, LP4K Mini-contactors On baseplate</p>	<p>LC2, LC8, LP2, LP5K Reversing mini-contactors On baseplate</p>
<p>On AM1DP200 or DE200 rail (35 mm)</p>	<p>On AM1DP200 or DE200 rail (35 mm)</p>
<p>On printed circuit board</p>	<p>On printed circuit board for reversing contactors or 2 mini-contactors side-by-side</p>
<p>LA2KT Electronic time delay contact blocks</p>	<p>On mini-contactors or reversing mini-contactors</p>

TeSys™ U Starter Dimensions

Table 18.131: TeSys U Starter Dimensions

Starter Controllers		Reversing	
Non-Reversing [7]		Rail Mounting	Screw Mounting
<p>Dimensions for Non-Reversing Rail Mounting: 126 (4.96), 135 (5.31), 154 (6.06), 45 (1.77), X1, X2.</p>	<p>Dimensions for Non-Reversing Screw Mounting: 126 (4.96), 135 (5.31), 73, 2.87, 30, 1.18, Ø4, .15, 163 (6.42).</p>	<p>Dimensions for Reversing Rail Mounting: 224 (8.82), 45 (1.77).</p>	<p>Dimensions for Reversing Screw Mounting: 120/125, 4.72/4.92, 29, 1.14, Ø4, .15, 233 (9.17).</p>

NOTE: Minimum electrical clearance:
X1: 35 mm for Ue = 440 V; and 70 mm for Ue = 500 and 690 V
X2: 0

Reversing Block for Mounting Separately from Power Base

	Rail Mounting	Screw Mounting
<p>Dimensions for Reversing Block Rail Mounting: 113 (4.45), 45 (1.77), 115, 4.53.</p>	<p>Dimensions for Reversing Block Screw Mounting: Ø4, .15, 104 (4.09), 36 (1.41).</p>	

Limiting Disconnecter LUALB1 [7]

<p>Dimensions for Limiting Disconnecter LUALB1: 135 (5.31), 154 (6.06), 93 (3.66), 45 (1.77).</p>

Door interlock Mechanisms

LU9APN43 and LU9APN44

<p>Dimensions for Door interlock Mechanisms: 7.05 to 18.72 (179 to 475.5), 1.73 (43.9), 0.77 (19.6), 2.36 (59.9), 2.50 (63.5), 0.29 (7.3), 8.66 (220.0), 9.34 (237.2), 0.97 (24.6), 1.18, 1.31, 30.0, 33.3, 3.87 (98.2), provision for 1/4 screws (2x).</p>

[7] Maximum depth (with Modbus™ communication module)

Altistart U01 and TeSys U Soft Starters, Mounting

Table 18.132: Altistart U01 and TeSys U Soft Starters

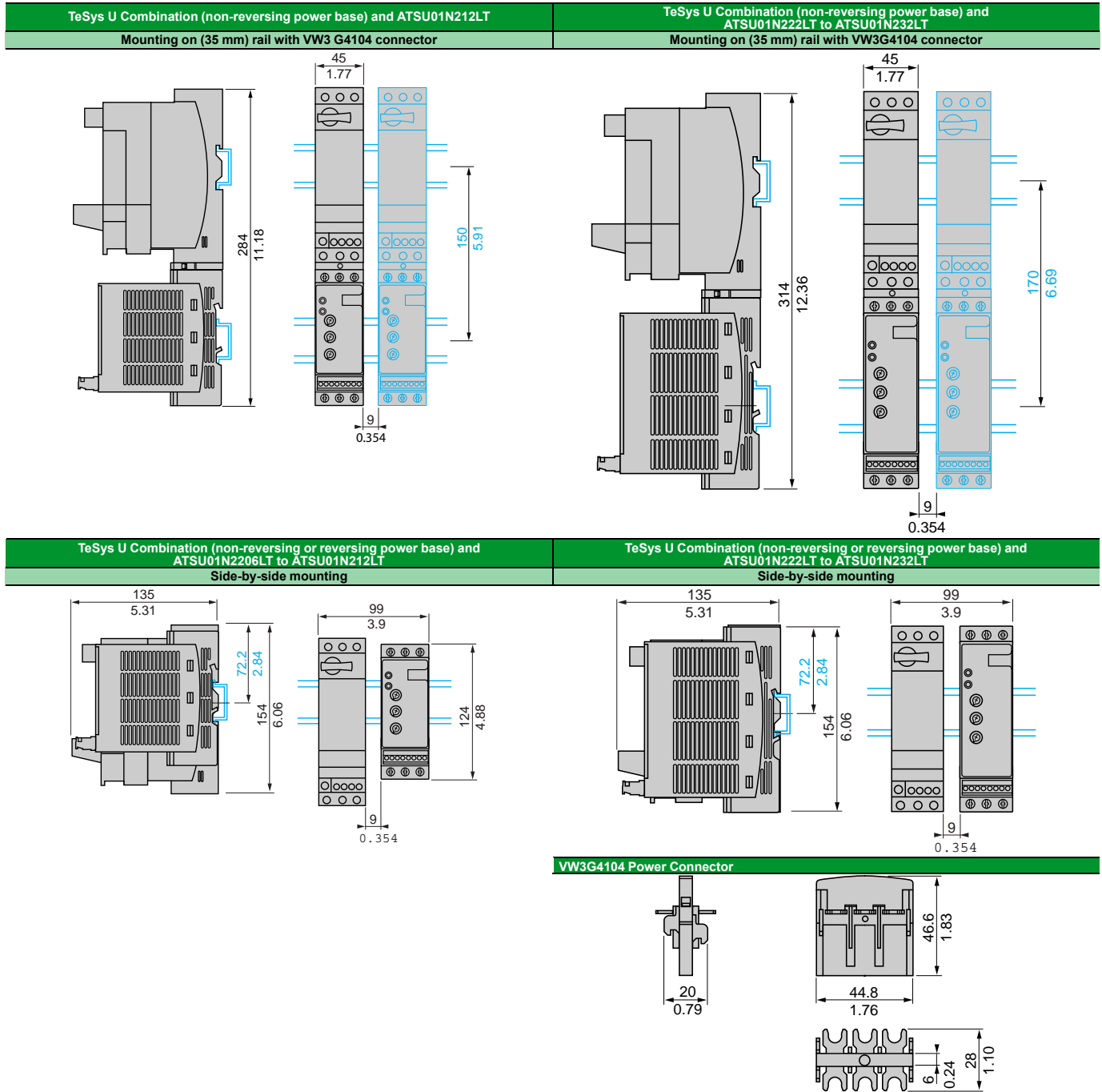

TeSys GV2 and GV3 Manual Starter and Protector Dimensions

Table 18.133: TeSys GV2 and GV3 Manual Starter and Protector Dimensions

GV2M		GV2AD, AM, AN, AU, AS, AX		GV2AE		Mounting of GV2M					
		Block GV2AD, AM, AN Block GV2AU, AS, AX 				On 35 mm L-r rail C = 78.5 mm (3.09") on AM1DP200 (35 x 7.5 mm) C = 86 mm (3.39") on AM1DE200, ED200 (35 x 15 mm) 					
GV2P		GV2AD, AM, AN, AU, AS, AX		GV2AK00		Mounting of GV2P					
		Block GV2AD, AM, AN Block GV2AU, AS, AX 				On 35 mm L-r rail C = 98.5 mm (3.88") on AM1DP200 (35 x 7.5 mm) C = 106 mm (4.17") on AM1DE200, ED200 (35 x 15 mm) 					
GV2AF4 + LAD31		GV2P + GV2GH7		GV2P + GV2GH7		GV2P + GV2GH7 + TeSys D contactor					
Combination GV2ME + TeSys D range contactor 		Combination GV2P + TeSys D range contactor 		for UL 508 Type E application 		for UL 508 Type E application 					
GV2ME +		LC2D09 to D18		LC2D25 and D32		GV2P +		LC2D09 to D18		LC2D25 and D32	
b		7.4 (188.6)		7.8 (199)		b		6.61 (168.1)		7.9 (199.5)	
c1		3.6 (92.7)		3.9 (99)		c1		4.6 (116.8)		4.6 (116.8)	
c		3.9 (98.2)		4.11 (104.5)		c		4.8 (122.3)		4.8 (122.3)	
d1		3.9 (98.3)		3.9 (98.3)		—		—		—	
d		4.1 (103.8)		1.4 (103.8)		—		—		—	
Surface mounting enclosure GV2MC0•						Flush mounting enclosure GV2MP0• (bracket cut-out)					
4 knock-outs for 16 mm plastic cable glands or no. 16 conduit.											

GV2	b		b1	
	in.	mm	in.	mm
MP01, MP02	5.51	140	5.00	127
MP03, MP04	5.24	133	4.61	117

Table 18.134: TeSys GV2 and GV3 Manual Starter and Protector Dimensions (cont'd)

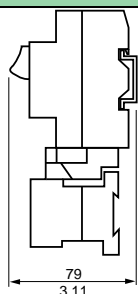
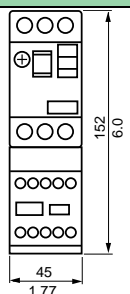
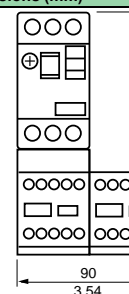
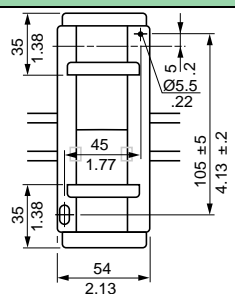
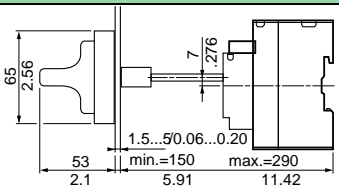
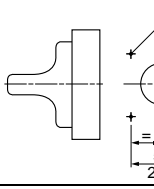
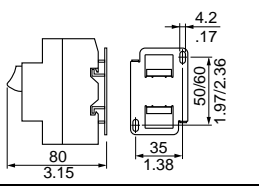
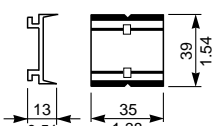
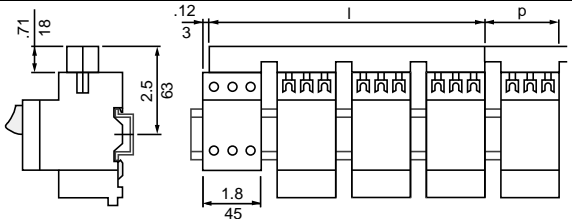
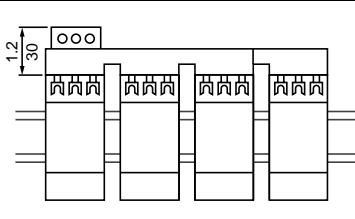
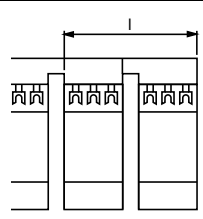
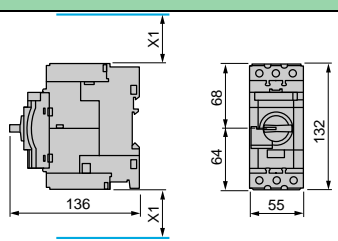
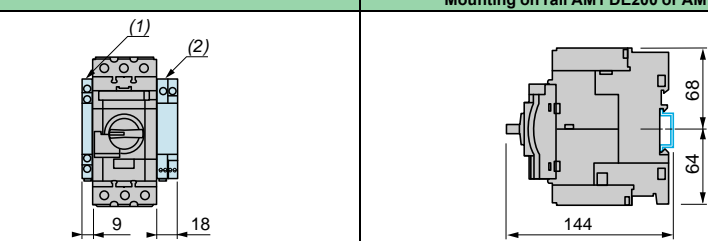
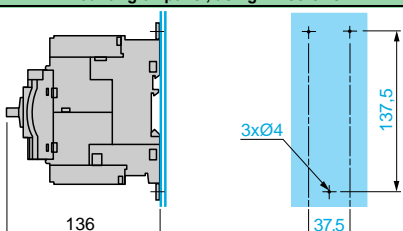
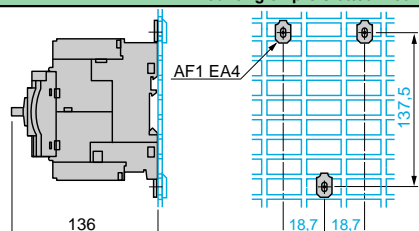
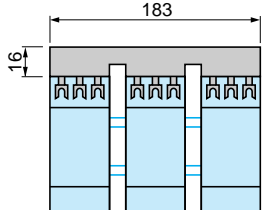
GV2M with GK2AF01 and LC1K	GV2M with GV2AF01 and LC1K	GV2M with GV2AF01 and LC2K	Adapter Plate GK2AF01																											
Dimensions (mm)																														
																														
79 3.11	152 6.0 45 1.77	152 6.0 90 3.54	35 1.38 5 .2 105 ±.5 4.13 ±.2 45 1.77 54 2.13																											
Mounting external operator GV2AP0	Door cut-out	GV2M on panel with GV2AF02 adapter plate	7.5 mm height compensation plate GV1F03																											
																														
65 2.56 53 2.1 1.5...50.06...0.20 min.=150 5.91 max.=290 11.42 7 .276 5.2 0.21	4xØ3.5 Ø43 0.14 1.7 54 2.13 54 2.13	4.2 .17 50/60 1.97/2.36 80 3.15 35 1.38	39 1.54 13 0.51 35 1.38																											
Sets of bus bars, GV2G445, GV2G454, GV2G472 with terminal block GV2G05		Sets of bus bars with terminal block GV1G09	Sets of bus bars GV2G245, GV2G254, GV2G272																											
																														
	<table border="1"> <thead> <tr> <th></th> <th>l</th> <th>P</th> </tr> </thead> <tbody> <tr> <td>GV2G445</td> <td>0.16 x 1.8 in. (4 x 45 mm)</td> <td>7.0 in. (179 mm)</td> <td>1.8 in. (45 mm)</td> </tr> <tr> <td>GV2G454</td> <td>0.16 x 2.1 in. (4 x 54 mm)</td> <td>8.1 in. (206 mm)</td> <td>2.1 in. (54 mm)</td> </tr> <tr> <td>GV2G472</td> <td>0.16 x 1.8 in. (4 x 45 mm)</td> <td>10.2 in. (260 mm)</td> <td>2.8 in. (72 mm)</td> </tr> </tbody> </table>		l	P	GV2G445	0.16 x 1.8 in. (4 x 45 mm)	7.0 in. (179 mm)	1.8 in. (45 mm)	GV2G454	0.16 x 2.1 in. (4 x 54 mm)	8.1 in. (206 mm)	2.1 in. (54 mm)	GV2G472	0.16 x 1.8 in. (4 x 45 mm)	10.2 in. (260 mm)	2.8 in. (72 mm)	<table border="1"> <tbody> <tr> <td>GV2G245</td> <td>0.08 x 1.8 in. (2 x 45 mm)</td> <td>3.5 in. (89 mm)</td> </tr> <tr> <td>GV2G254</td> <td>0.08 x 2.1 in. (2 x 54 mm)</td> <td>3.9 in. (98 mm)</td> </tr> <tr> <td>GV2G272</td> <td>0.08 x 2.8 in. (2 x 72 mm)</td> <td>4.6 in. (116 mm)</td> </tr> <tr> <td>GV2G354</td> <td>0.12 x 2.1 in. (3 x 54 mm)</td> <td>6.0 in. (152 mm)</td> </tr> </tbody> </table>	GV2G245	0.08 x 1.8 in. (2 x 45 mm)	3.5 in. (89 mm)	GV2G254	0.08 x 2.1 in. (2 x 54 mm)	3.9 in. (98 mm)	GV2G272	0.08 x 2.8 in. (2 x 72 mm)	4.6 in. (116 mm)	GV2G354	0.12 x 2.1 in. (3 x 54 mm)	6.0 in. (152 mm)	
	l	P																												
GV2G445	0.16 x 1.8 in. (4 x 45 mm)	7.0 in. (179 mm)	1.8 in. (45 mm)																											
GV2G454	0.16 x 2.1 in. (4 x 54 mm)	8.1 in. (206 mm)	2.1 in. (54 mm)																											
GV2G472	0.16 x 1.8 in. (4 x 45 mm)	10.2 in. (260 mm)	2.8 in. (72 mm)																											
GV2G245	0.08 x 1.8 in. (2 x 45 mm)	3.5 in. (89 mm)																												
GV2G254	0.08 x 2.1 in. (2 x 54 mm)	3.9 in. (98 mm)																												
GV2G272	0.08 x 2.8 in. (2 x 72 mm)	4.6 in. (116 mm)																												
GV2G354	0.12 x 2.1 in. (3 x 54 mm)	6.0 in. (152 mm)																												
GV3P																														
Dimension		Mounting on rail AM1 DE200 or AM1 ED201																												
																														
X1 = Electrical clearance (ISC max) 40 mm for Ue < 500 V; 50 mm for Ue < 690 V		Blocks GV AN●●, GV AD●●, GV AM11 Block GV3 AU●● and GV3 AS●●																												
Mounting on panel, using M4 screws		Mounting on pre-slotted mounting plate AM1PA																												
																														
136 3xØ4 137.5 37.5		136 AF1 EA4 137.5 18.7 18.7																												
																														
		183 16																												

NOTE: Leave a space of 9 mm between 2 manual motor protectors: either an empty space or side-mounting add-on contact blocks. Horizontal mounting is possible: please consult your regional sales office.

TeSys GV7 Manual Starter and Protector Dimensions

BV4 With Toggle

With EverLink Connector

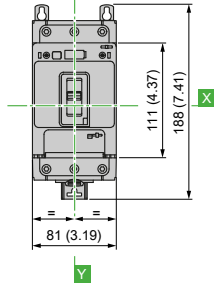
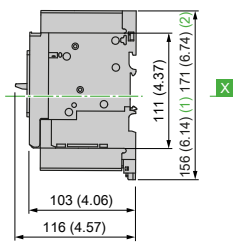

With Crimp Lug Connector

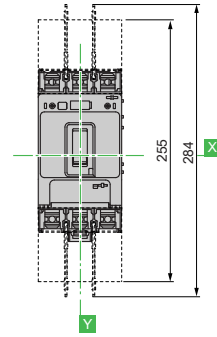
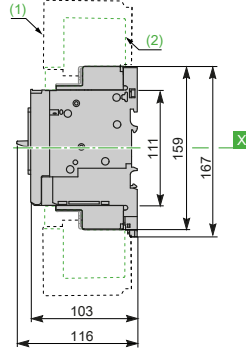

GV4PB

With EverLink Connector

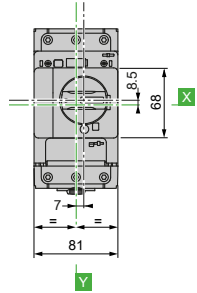
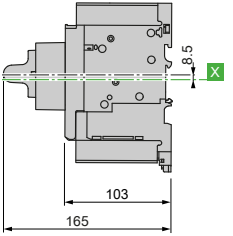

With Crimp Lug Connector

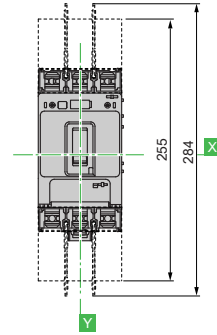
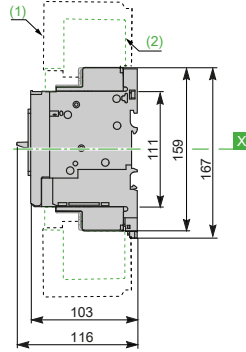

SDx Module

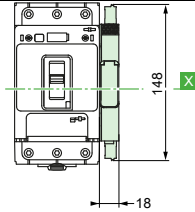

BV4 and GV4PB With Extended Rotary Handle

Front extended rotary handle GV4APN01, GV4APN02, GV4APN04

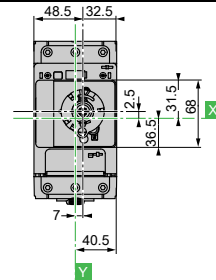
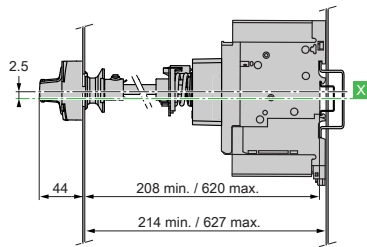

Front and side extended rotary handle, door/side panel cut-out

Front and side extended rotary handle

IP65, door panel cut-out

IP54, door/side panel cut-out

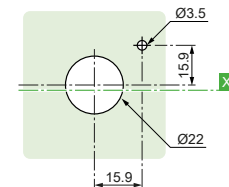
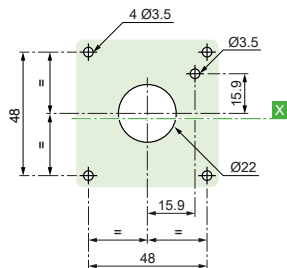
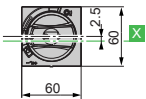
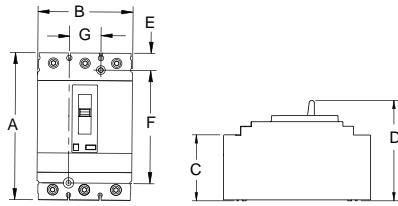

Table 18.135: GV5PB and GV6PB Motor Protective Circuit Breakers

Circuit Breaker Frame	Dimensions — Inches						
	A	B	C	D	E	F	G
GV5PB150	6.40	4.12	2.87	4.36	0.74	1.92	1.38
GV5PB250	7.52	4.12	2.87	5.00	1.30	4.92	1.38
GV6PB	13.38	5.51	3.75	6.61	2.22	7.87	1.77

GV5PB



GV6PB

